

# Installation, Support, and Maintenance Guide

iQ 200 Rackmount Satellite Router

**Router Products**

Evolution and Velocity

September 25, 2018



---

Copyright © 2018. VT iDirect, Inc., 13861 Sunrise Valley Drive, Suite 300, Herndon, VA 20171, USA.

All rights reserved. Reproduction in whole or in part without permission is prohibited. Information contained herein is subject to change without notice. The specifications and information regarding the products in this document are subject to change without notice. All statements, information and recommendations in this document are believed to be accurate, but are presented without warranty of any kind, express, or implied. Users must take full responsibility for their application of any products. Trademarks, brand names and products mentioned in this document are the property of their respective owners. All such references are used strictly in an editorial fashion with no intent to convey any affiliation with the name or the product's rightful owner.



**VT iDirect®** is a global leader in IP-based satellite communications providing technology and solutions that enable our partners worldwide to optimize their networks, differentiate their services and profitably expand their businesses. Our product portfolio, branded under the name **iDirect®**, sets standards in performance and efficiency to deliver voice, video and data connectivity anywhere in the world. **VT iDirect®** is the world's largest TDMA enterprise VSAT manufacturer and is the leader in key industries including mobility, military/government and cellular backhaul.

Company Web site: [www.idirect.net](http://www.idirect.net) ~ Main Phone: 703.648.8000

TAC Contact Information: Phone: 703.648.8151 ~ Email: [tac@idirect.net](mailto:tac@idirect.net) ~ Web site: [tac.idirect.net](http://tac.idirect.net)



**iDirect Government™**, created in 2007, is a wholly owned subsidiary of iDirect and was formed to better serve the U.S. government and defense communities.

Company Web site: [www.idirectgov.com](http://www.idirectgov.com) ~ Main Phone: 703.648.8118

TAC Contact Information: Phone: 703.648.8111 ~ Email: [tac@idirectgov.com](mailto:tac@idirectgov.com) ~ Web site: [tac.idirectgov.com](http://tac.idirectgov.com)

Document Name: ISM\_iQ200Rackmount\_T0001032\_RevA\_09252018.pdf

Document Part Number: T0001032

---

---

# Revision History

The following table shows all revisions for this document. To determine if this is the latest revision, check the TAC Web site at <http://tac.direct.net>.

Revision	Date	Updates
A	September 25, 2018	Initial release of the document.

*Revision History*

---

---

---

---

# Contents

<b>About</b> .....	<b>xi</b>
Intended Audience .....	xi
Manual Contents .....	xi
Document Conventions .....	xii
Document Set .....	xiii
Related Training Services .....	xiii
Getting Help .....	xiii
Warranty, RoHS, WEEE, Declaration of Conformity .....	xiv
<b>1 Introduction</b> .....	<b>1</b>
1.1 Features .....	1
1.2 Power Supply Options .....	2
<b>2 Specifications</b> .....	<b>3</b>
2.1 Mechanical and Environmental Specifications .....	3
2.2 Power Specifications .....	4
2.3 RF Specifications .....	5
<b>3 Interfaces</b> .....	<b>7</b>
3.1 iQ 200 Rackmount Satellite Router Front LEDs .....	7
3.2 iQ 200 Rackmount Front Panel LED Status Descriptions .....	8
3.3 iQ 200 Rackmount Satellite Router Rear Panel Descriptions .....	10
<b>4 Installation</b> .....	<b>13</b>
4.1 Installation Steps at a Glance .....	13

4.1.1 Pre-Installation Guidelines . . . . .	13
4.1.2 Installation Checklist . . . . .	14
4.2 Tools and Supplies Required for Installation . . . . .	15
4.3 Unpacking iDirect Equipment . . . . .	15
4.4 Components Typically Included in an Order . . . . .	16
4.5 Mounting the iQ 200 Rackmount Satellite Router . . . . .	16
4.5.1 Installing With an AC Power Supply (Option 1) . . . . .	17
4.5.2 Installing With a 36-76 VDC Power Supply (Option 2) . . . . .	17
4.6 Preparing the PC for Connection to the iQ 200 Rackmount Satellite Router . . .	18
4.7 Configuring the iQ 200 Rackmount Satellite Router . . . . .	18
<b>5 Maintenance . . . . .</b>	<b>19</b>
5.1 Safety Guidelines to Observe During Servicing . . . . .	19
5.1.1 Servicing . . . . .	19
5.1.2 Conditions Requiring Service . . . . .	19
5.2 Maintaining the iQ 200 Rackmount Satellite Router . . . . .	20
5.2.1 Temperature Control . . . . .	20
5.2.2 90 day maintenance . . . . .	20
5.3 Troubleshooting the iQ 200 Rackmount Router . . . . .	21
5.4 Removing and Replacing the Power Module . . . . .	21
5.5 Repacking the iQ 200 Rackmount Satellite Router . . . . .	22
<b>Appendix A Acronyms and Abbreviations . . . . .</b>	<b>23</b>
<b>Appendix B Tools Needed . . . . .</b>	<b>27</b>
<b>Appendix C Cable Preparation . . . . .</b>	<b>29</b>
C.1 Coax Cable Preparation . . . . .	29
C.2 Ethernet Port Pinouts . . . . .	34
C.2.1 Ethernet Port Pinouts . . . . .	34
C.2.2 Straight Through and Crossover RJ-45 Cables . . . . .	35
C.3 Console Port Connection . . . . .	35

**Appendix D DC Power Supply Installation . . . . . 37**

**Appendix E iQ 200 Rackmount Satellite Router Reset . . . . . 41**

    E.1 Level 0 Reset . . . . . 41

    E.2 Level 1 Reset . . . . . 41

---

---

## Figures

Figure 1-1. iQ 200 Rackmount Satellite Router . . . . .	1
Figure 3-1. iQ 200 Rackmount Satellite Router Front Panel LED Display . . . . .	7
Figure 3-2. iQ 200 Rackmount Satellite Router Rear Panel Description . . . . .	10
Figure B-1. Recommended Installation Tools . . . . .	27
Figure C-1. Coax Cable Cutting Technique . . . . .	30
Figure C-2. Cutting Technique for Removing Foil in the Braid. . . . .	31
Figure C-3. Procedure to Cut the Quad Shield Cable. . . . .	32
Figure C-4. Attaching the Compression fitting F-type Connector . . . . .	33
Figure C-5. Compression fitting F-Type Weatherproof Plug and Tool . . . . .	33
Figure C-6. RJ-45 Cable Connectors: Receptacle and Plug . . . . .	34
Figure C-7. Holding the RJ-45 Cable Connectors . . . . .	35
Figure C-8. RJ-45 to DB-9 Female DTE Adapter . . . . .	36
Figure D-1. DC-DC Power Supply Assembly at a Glance . . . . .	38



---

---

## Tables

Table 1-1. Power Supply Configurations .....	2
Table 2-1. Mechanical and Environmental Specifications.....	3
Table 2-2. Power Specifications .....	4
Table 2-3. RF Specifications .....	5
Table 3-1. iQ 200 Rackmount Satellite Router Front Panel Description .....	8
Table 3-2. iQ 200 Rackmount Satellite Router Front Panel LED Descriptions.....	8
Table 3-3. iQ 200 Rackmount Satellite Router Rear Panel Descriptions .....	10
Table 5-1. Troubleshooting Events and Actions to Take .....	21
Table 5-2. Removing and/or Replacing the Power Module .....	22
Table B-1. Recommended Installation Tools and Equipment.....	27
Table C-1. Coax Trim Dimensions.....	30
Table C-2. Ethernet Port Pinouts .....	34
Table C-3. RJ-45 to DB-9 Pinouts .....	35
Table D-1. iQ 200 Rackmount Router DC Power Module Connector Parts .....	37
Table D-2. Power Module Power Cable Installation Instructions Detail.....	38



---

---

# About

This manual provides important safety information and explains how to install and maintain the iDirect iQ 200 Rackmount Satellite Router.

This chapter contains the following sections:

- [Intended Audience](#)
- [Manual Contents](#)
- [Document Conventions](#)
- [Document Set](#)
- [Related Training Services](#)
- [Getting Help](#)
- [Warranty, RoHS, WEEE, Declaration of Conformity](#)

## Intended Audience

This manual is intended for use by the VSAT (Very Small Aperture Terminal) equipment installer, System Engineer, and Network Operator responsible for maintaining the iDirect Network. Only qualified service personnel should install the iQ 200 Rackmount Satellite Router. Familiarity with cabling and wiring practices is beneficial.

## Manual Contents

In addition to the information in this chapter, this manual also includes the following:

- [Chapter 1, Introduction on page 1](#), provides an overview and description of the iQ 200 Rackmount Satellite Router.
- [Chapter 2, Specifications on page 3](#) describes the mechanical, environmental and RF specifications of the iQ 200 Rackmount Satellite Router.
- [Chapter 3, Interfaces on page 7](#) provides connector descriptions of the iQ 200 Rackmount Satellite Router.
- [Chapter 4, Installation on page 13](#) describes procedures for installing the iQ 200 Rackmount Satellite Router.

- [Chapter 5, Maintenance on page 19](#) describes maintenance procedures for the iQ 200 Rackmount Satellite Router.



**NOTE:** A basic list of acronyms and abbreviations can be found in [Appendix A, Acronyms and Abbreviations](#).

## Document Conventions

This section illustrates and describes the conventions used throughout this document.

Convention	Description	Example
<b>Command</b>	Used when the user is required to enter a command at a command line prompt or in a console.	Enter the command: <code>cd /etc/snmp/</code>
Terminal Output	Used when showing resulting output from a command that was entered at a command line or on a console.	<code>crc report all</code> 8350.3235 : DATA CRC [ 1 ] 8350.3502 : DATA CRC [5818] 8350.4382 : DATA CRC [ 20 ]
<b>Screen Reference</b>	Used when referring to text that appears on the screen on a Graphical User Interface (GUI). Used when specifying names of commands, menus, folders, tabs, dialogs, list boxes, and options.	1. To add a remote to an inroute group, right-click the Inroute Group and select <b>Add Remote</b> . The Remote dialog box has a number of user-selectable tabs across the top. The <b>Information</b> tab is visible when the dialog box opens.
<b>Hyperlink</b>	Used to show all hyperlinked text within a document or external links such as web page URLs.	For instructions on adding a line card to the network tree, see <a href="#">Adding a Line Card on page 108</a> .



**WARNING:** A *Warning* highlights an essential operating or maintenance procedure, practice, condition, or statement which, if not strictly observed, could result in injury, death, or long term health hazards.



**CAUTION:** A *Caution* highlights an essential operating or maintenance procedure, practice, condition, or statement which, if not strictly observed, could result in damage to, or destruction of, equipment or a condition that adversely affects system operation.



**NOTE:** A *Note* is a statement or other notification that adds, emphasizes, or clarifies essential information of special importance or interest.

---

## Document Set

The following iDirect documents are available at TAC and contain information relevant to installing and using iDirect satellite network software and equipment. Refer to [Getting Help on page xiii](#) for TAC access information.

### For Evolution®:

- *iDX iBuilder User Guide*
- *iDX iMonitor User Guide*
- *Web iSite User Guide*
- *Terminal WUI User Guide*
- *Satellite Router Installation and Commissioning Guide*
- *Evolution Release Notes*
- *Evolution Technical Reference Guide*
- *Quick Start Guide (QSG), included in package with router*

### For iDirect Velocity®:

- *Pulse NMS User Guide*
- *Regulatory Guide (Quick Start Guide)*
- *iDirect Velocity® Software Release Notes*
- *Terminal WUI User Guide*
- *Configuring iDirect Velocity Networks Using Pulse*

## Related Training Services

iDirect offers scheduled classroom training at various global training centers, as well as eLearning, in the installation, operation, maintenance and management of iDirect satellite networks. For training course descriptions and available training dates visit the iDirect web site **Training and Services** at: <http://www.idirect.net/Training-and-Services.aspx> or call +1 (800) 648-8240 for class registration and information.

## Getting Help

The iDirect Technical Assistance Center (TAC) and the iDirect Government Technical Assistance Center (TAC) are available to provide assistance 24 hours a day, 365 days a year. Software user guides, installation procedures, FAQs, and other documents that support iDirect and Direct Government products are available on the respective TAC Web site:

- Access the iDirect TAC Web site at <http://tac.idirect.net>
- Access the iDirect Government TAC Web site at <http://tac.idirectgov.com>

The iDirect TAC may be contacted by telephone or email:

- Telephone: (703) 648.8151
- E-mail: [tac@idirect.net](mailto:tac@idirect.net)

The Direct Government TAC may be contacted by telephone or email:

- Telephone: (703) 648.8111
- Email: [tac@idirectgov.com](mailto:tac@idirectgov.com)

iDirect and iDirect Government produce documentation that are technically accurate, easy to use, and helpful to our customers. Please assist us in improving this document by providing feedback. Send comments to:

- iDirect: [techpubs@idirect.net](mailto:techpubs@idirect.net)
- iDirect Government: [techpubs@idirectgov.com](mailto:techpubs@idirectgov.com)

For sales or product purchasing information contact iDirect Corporate Sales at the following telephone number or e-mail address:

- Telephone: (703) 648.8000
- E-mail: [sales@idirect.net](mailto:sales@idirect.net)

## Warranty, RoHS, WEEE, Declaration of Conformity

Complete iDirect hardware product statements for the iQ 200 Rackmount Satellite Router are available at these Web sites:

- <http://www.idirect.net/warranty>, for the hardware warranty
- <http://www.idirect.net/rohs>, for the RoHS statement of compliance
- <http://www.idirect.net/weee>, for the WEEE statement of compliance
- <http://www.idirect.net/doc>, for the Declaration of Conformity

---

# 1 Introduction

The iQ 200 Rackmount is iDirect's next-generation DVB-S2/DVB-S2X remote with Adaptive TDMA returns and is ideal for cost-effective, small to medium enterprise, and maritime applications. The iQ 200 Rackmount combines high-performance iQ series features with mobility and is compatible on both Evolution® and iDirect Velocity®.

This chapter contains the following sections:

- [Section 1.1, Features on page 1](#)
- [Section 1.2, Power Supply Options on page 2](#)

This manual explains how to safely install and maintain the iQ 200 Rackmount Satellite Router. The iQ 200 Rackmount Satellite Router is shown in [Figure 1-1](#).



Figure 1-1. iQ 200 Rackmount Satellite Router

## 1.1 Features

The iQ 200 Rackmount Satellite Router supports the following features:

- Single DVB-S2X (>100 Msps) demodulator
- Single A-TDMA (15 Msps) modulator
- Dual Image support
- OpenAMIP Mobility Support
- AES Encryption
- Two independent Gig-E LAN Ports
- Console port for NMEA GPS input
- Web GUI / Web Services support

## 1.2 Power Supply Options



**NOTE:** The iQ 200 Rackmount can be ordered in any of the two configurations specified in [Table 1-1](#). The Power Supply Unit (PSU) is a Field Replaceable Unit (FRU) and can be swapped in the field.

The iQ 200 Rackmount Satellite Router is available with these power supply configurations:

**Table 1-1. Power Supply Configurations**

Power Supply Option	Description
100-240V AC +24V Power Supply (Standard)	This AC power module for the iQ 200 Rackmount Satellite Router is standard with a single +24V power support for the BUC.
36-76V DC +24 V Power Supply	This DC power module for the iQ 200 Rackmount Satellite Router comes with a +24V power support for a +24V BUC.



---

---

# 2 Specifications

This chapter describes the mechanical, environmental, power, RF specifications for the iQ 200 Rackmount Satellite Router and contains the following sections:

- [Section 2.1, Mechanical and Environmental Specifications on page 3](#)
- [Section 2.2, Power Specifications on page 4](#)
- [Section 2.3, RF Specifications on page 5](#)

## 2.1 Mechanical and Environmental Specifications

The installation site must be able to accommodate the iQ 200 Rackmount Satellite Router mechanical and environmental specifications. The mechanical and environmental specifications are listed in [Table 2-1](#).

**Table 2-1. Mechanical and Environmental Specifications**

Category	Description
Dimensions	W 44.5 cm (17.5 in) x D 32 cm (12.6 in) x H 4.45 cm (1.75 in)
Weight	4.5 kg (10 lbs)
Heat Dissipation	16W average
Airflow	Front Panel Fan Assist (2 fans), Power Supply (1 fan), Rear Exhaust, No Filter
Ambient Temperature	
Operational	+32° F to +140° F (0° C to 60° C) De-rate 1.8° F (1° C) per 1,000 ft (304 m) above 5,000 ft (1,524 m) Safety certified to 10,000 ft (3,048 m)
Storage	-40° F to +185° F (-40° C to +85° C)
Temperature Gradient	1.0 C per minute
Relative Humidity	
Operational	10-90%, non-condensing
Storage	5 to 95%

Table 2-1. Mechanical and Environmental Specifications (continued)

Category	Description
Altitude	Operational ≤ 10,000 ft (3,048 m)
	Storage ≤ 35,000 ft (10,668 m)
Shock	Operational ≥ 10 G
	Survival ≤ 40 G (ISTA-1A)
Vibration	Operational ETSI 300 019-2-6 Class 6.1, 5-200Hz

## 2.2 Power Specifications

The iQ 200 Rackmount Satellite Router power specifications are listed in [Table 2-2](#).



**CAUTION:** If negative voltages are used such as Telecom -48VDC, the negative most voltage is always connected to -ve terminal (in the Telecom case this would be -48V) and the positive most voltage is always connected to the +ve terminal (in the Telecom case this would be 0VR). Chassis can be referenced to +ve, -ve or left floating (i.e. not connected to either +ve or -ve) as required as the power module is fully isolated input to the chassis.

Table 2-2. Power Specifications

Category	Description
Input Voltage Range	Option 1: 100-240 VAC, Auto-Ranging Option 2: 36-76 VDC
Frequency	Options 1: 50-60 Hz, Auto-Ranging
Remote Power Consumption	150 W (with 4 A BUC and 0.5 A LNB) MAX
AC PSU Current Rating	Option 1: 2.7 A, 270 W (Power Supply capability)
DC PSU Current Rating	Option 2: 8.3 A, 310 W (Power Supply capability)
DC Power @ TX Output Connector	+24 V @ 4.0 A (Max)
DC Power @ RX Input Connector	13, 18, 21 VDC @ 500mA (Max)
Protection	Over-Voltage Protection for LNB and BUC DC Over-Current Limiting for LNB and BUC DC Options 1: Primary AC fuse within PS module (250 VAC, T6.3 A) Option 2: Primary DC fuse within PS module (250 VDC, 16 A)
AC Power Cord	Supplied, per country of use

Table 2-2. Power Specifications (continued)

Category	Description
DC Input Connector	Self-capturing terminal block, 14-18 AWG
Efficiency of the Power Supply	87% (MIN)

## 2.3 RF Specifications

The iQ 200 Rackmount Satellite Router RF specifications are listed in [Table 2-3](#).

Table 2-3. RF Specifications

Category	Description										
LNB Support	22 kHz tone for High / Low Band										
IF Interface, Impedance	Type "F", Zo = 75 ohms										
Frequency Range	<table border="0"> <tr> <td>Transmit</td> <td>950 - 2150 MHz</td> </tr> <tr> <td>Receive</td> <td>950 - 2150 MHz</td> </tr> </table>	Transmit	950 - 2150 MHz	Receive	950 - 2150 MHz						
Transmit	950 - 2150 MHz										
Receive	950 - 2150 MHz										
Tuning Step Size	<table border="0"> <tr> <td>Transmit</td> <td>10 Hz</td> </tr> <tr> <td>Receive</td> <td>55 KHz</td> </tr> </table>	Transmit	10 Hz	Receive	55 KHz						
Transmit	10 Hz										
Receive	55 KHz										
RF Power	<table border="0"> <tr> <td>Transmit</td> <td>Pmax of +0 dBm to Pmin of -35 dBm</td> </tr> <tr> <td>Receive, Maximum</td> <td>Max composite wide band receive level: a) -5 dBm for symbol rates. 45 Msps b) 10 dB above wanted signal power level for symbol rates &gt; 45 Msps</td> </tr> <tr> <td>Receive, Minimum</td> <td>Minimum Receive Level: <math>-115+10*\log(F_{sym}(sps))</math> single carrier Receive adjust-ability- AGC Dynamic Range adjustment</td> </tr> </table>	Transmit	Pmax of +0 dBm to Pmin of -35 dBm	Receive, Maximum	Max composite wide band receive level: a) -5 dBm for symbol rates. 45 Msps b) 10 dB above wanted signal power level for symbol rates > 45 Msps	Receive, Minimum	Minimum Receive Level: $-115+10*\log(F_{sym}(sps))$ single carrier Receive adjust-ability- AGC Dynamic Range adjustment				
Transmit	Pmax of +0 dBm to Pmin of -35 dBm										
Receive, Maximum	Max composite wide band receive level: a) -5 dBm for symbol rates. 45 Msps b) 10 dB above wanted signal power level for symbol rates > 45 Msps										
Receive, Minimum	Minimum Receive Level: $-115+10*\log(F_{sym}(sps))$ single carrier Receive adjust-ability- AGC Dynamic Range adjustment										
Tx SSB Phase Noise	<table border="1"> <thead> <tr> <th>Frequency</th> <th>Phase Noise</th> </tr> </thead> <tbody> <tr> <td>1 KHz</td> <td>-85 dBc/Hz</td> </tr> <tr> <td>10 KHz</td> <td>-95 dBc/Hz</td> </tr> <tr> <td>100 KHz</td> <td>-90 dBc/Hz</td> </tr> <tr> <td>1 MHz</td> <td>-110 dBc/Hz</td> </tr> </tbody> </table>	Frequency	Phase Noise	1 KHz	-85 dBc/Hz	10 KHz	-95 dBc/Hz	100 KHz	-90 dBc/Hz	1 MHz	-110 dBc/Hz
Frequency	Phase Noise										
1 KHz	-85 dBc/Hz										
10 KHz	-95 dBc/Hz										
100 KHz	-90 dBc/Hz										
1 MHz	-110 dBc/Hz										
Receiver Noise Figure	15 dB										
Transmit Carrier Suppression	$\leq -35$ dBc										
Discrete Spurs and Harmonic Content	In-band (900-2150 MHz), with output at -30 dBm: $\leq -35$ dBc										

Table 2-3. RF Specifications (continued)

Category	Description
Transmitter Muting	50 dB (min) between carrier on and off states within 0.1 us at the same attenuation state

---

---

---

# 3 Interfaces

This chapter describes the iQ 200 Rackmount Satellite Router physical interfaces and LEDs, and contains the following sections:

- Section 3.1, *iQ 200 Rackmount Satellite Router Front LEDs* on page 7
- Section 3.2, *iQ 200 Rackmount Front Panel LED Status Descriptions* on page 8
- Section 3.3, *iQ 200 Rackmount Satellite Router Rear Panel Descriptions* on page 10

## 3.1 iQ 200 Rackmount Satellite Router Front LEDs

The iQ 200 Rackmount Satellite Router front panel is shown in [Figure 3-1](#) and defined in [Table 3-1](#).

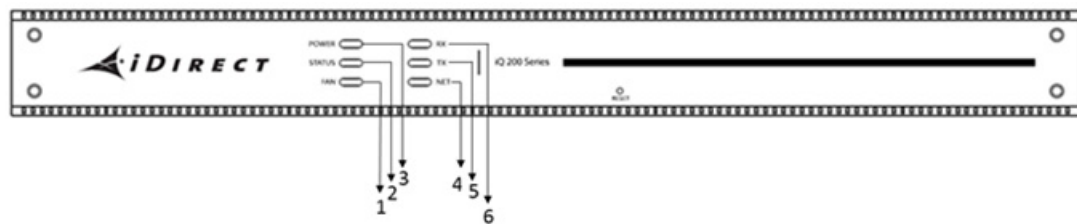

Figure 3-1. iQ 200 Rackmount Satellite Router Front Panel LED Display



**NOTE:** The descriptions of the LEDs may vary between software releases. Check the release-specific *Terminal WUI User Guide and Release Notes* for details.

Table 3-1. iQ 200 Rackmount Satellite Router Front Panel Description

Callout - Label	Description
1 - FAN	Provides fan status
2 - STATUS	Indicates basic operational state and problems with core hardware
3 - POWER	Indicates power status and any power-related problems
4 - NET	Indicates the state of the satellite network connection
5 - TX	Indicates the state of the transmitter
6 - RX	Indicates the state of the receiver
7- RESET	iQ 200 Rackmount internal reset button

## 3.2 iQ 200 Rackmount Front Panel LED Status Descriptions

Descriptions for states of LEDs may vary between software releases. Check the release-specific *Terminal WUI User Guide and Release Notes* for details. [Figure 3-1 on page 7](#) shows the front panel and [Table 3-2](#) describes the front panel LED color and status information:

Table 3-2. iQ 200 Rackmount Satellite Router Front Panel LED Descriptions

Label	Signal Color/Type	Definition
FAN		Indicates the fan status
	Solid Green	Indicates the correct operation of the fan
	Red	Indicates either the fan and/or temperature is at-fault
POWER		Indicates iQ 200 Rackmount power status and any power-related problems
	Off	No or low power input to the modem
	Solid Green	The modem is powered on
STATUS		Boot Sequence and Overall Hardware Status
	1/2 second flashing Green	Remote initializing
	Solid Green	Initialization complete
RX		Provides downstream receive status
	Solid Amber	Downstream carrier configured, demodulator not yet locked
	1 second flashing Amber	Downstream carrier configured, demodulator locked to downstream carrier, Network Clock Reference (NCR) not yet locked
	Solid Green	Downstream carrier configured, demodulator and NCR locked to downstream carrier
TX		Indicates the state of the transmitter

Table 3-2. iQ 200 Rackmount Satellite Router Front Panel LED Descriptions (continued)

Label	Signal Color/Type	Definition
	Solid Amber	Transmitter is disabled
	1 second flashing Amber	Transmitter acquiring upstream connection
	Solid Green	Transmitter upstream connection acquired
<b>NET</b>		Modem Network Status: Indicates the state of the satellite network connection
	1 second flashing Green	Network acquisition in progress
	Solid Green	Network acquired

### 3.3 iQ 200 Rackmount Satellite Router Rear Panel Descriptions

The iQ 200 Rackmount Satellite Router rear panel is displayed in [Figure 3-2](#) and defined in [Table 3-3](#) on page 10.

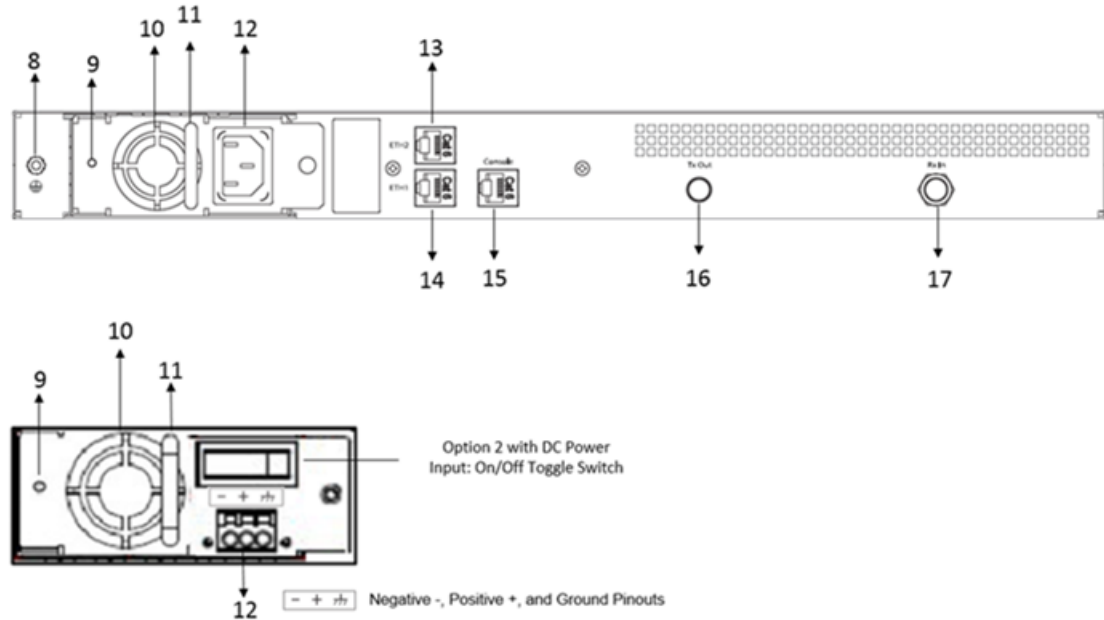

Figure 3-2. iQ 200 Rackmount Satellite Router Rear Panel Description

Table 3-3. iQ 200 Rackmount Satellite Router Rear Panel Descriptions

Callout	Label	Interface Definition and Connector Type
8		Grounding stud, #6-32tpi
9	no label	Power Supply Module LED OFF - No valid output Green - Valid DC output
10	no label	Fan
11	no label	Power supply extraction handle
12	no label	Terminal Block Header Option 1: AC input connector IEC-320-C13 Option 2: DC input terminals - Negative, Positive, and Ground; 14-16 AWG



Table 3-3. iQ 200 Rackmount Satellite Router Rear Panel Descriptions (continued)

Callout	Label	Interface Definition and Connector Type
13 and 14	ETH1 and ETH2	Ethernet Communications Ports, RJ-45 10/100/1000 Ethernet ports, 802.1q VLAN <b>NOTE:</b> The Ethernet ports are 1G. They are marked 10G incorrectly.
15	Console	Console Communications Port, RS-232 Serial, RJ-45
16	TX OUT	L-Band Transmit signal to Block Up Converter (BUC) capable of 10 MHz or 50 MHz Reference; 75 Ohm, F-Type; +24 V @ 4.0 A (Max)
17	RX IN	L-Band Receive signal from Low Noise Block Down Converter (LNB); 75 Ohm, F-Type; 13, 18, 21 VDC @ 500 mA (Max)



---

---

# 4 Installation

This chapter describes the guidelines and procedures for installing the iQ 200 Rackmount Satellite Router and contains these sections:

- [Section 4.1, \*Installation Steps at a Glance\* on page 13](#)
- [Section 4.2, \*Tools and Supplies Required for Installation\* on page 15](#)
- [Section 4.3, \*Unpacking iDirect Equipment\* on page 15](#)
- [Section 4.4, \*Components Typically Included in an Order\* on page 16](#)
- [Section 4.5, \*Mounting the iQ 200 Rackmount Satellite Router\* on page 16](#)
- [Section 4.6, \*Preparing the PC for Connection to the iQ 200 Rackmount Satellite Router\* on page 18](#)
- [Section 4.7, \*Configuring the iQ 200 Rackmount Satellite Router\* on page 18](#)



**NOTE:** See [Document Conventions](#) on page xii for a description of the warning icons that are used in this manual.

## 4.1 Installation Steps at a Glance



**CAUTION:** Only trained and qualified personnel should be allowed to install or replace this equipment.

The following steps must be followed for successful installation of the iQ 200 Rackmount Satellite Router. Each step refers to other sections or appendices, as appropriate, with more detailed information.

### 4.1.1 Pre-Installation Guidelines

iQ 200 Rackmount Satellite Router installation guidelines:

- When selecting the site, consider accessibility, power availability, signal, network connections, and the possibility of future expansion
- Carefully examine the work area for possible hazards, such as wet floor, ungrounded power extension cables, and missing safety grounds
- Install the iQ 200 Rackmount Satellite Router in a location where access is unobstructed

- Ensure the iQ 200 Rackmount Satellite Router has adequate ventilation
- Do not install the iQ 200 Rackmount Satellite Router on the floor
- Select a suitable dust free location
- To protect the equipment and to avoid personal injury, observe the physical and environmental considerations below when installing an iQ 200 Rackmount Satellite Router:
  - **Ventilation**

A single-core protective vent on the back of the chassis provides pressure equalization and allows reliable operation of the product. To protect the chassis from overheating do not place this product in a built-in installation, such as a bookcase or enclosed rack, unless proper ventilation is provided or the manufacturer instructions have been followed
  - **Power Cord Protection**

Route power supply cords so they will not be walked on or pinched; pay particular attention to cords at plugs, convenience receptacles, and at the exit points
  - **Overloading**

Do not overload wall outlets, extension cords, or integral convenience receptacles
  - **Heat**

Do not place the iQ 200 Rackmount Satellite Router near heat sources, such as radiators, heat registers, stoves, or other products (including amplifiers) that produce heat
  - **Attachments**

Do not use attachments unless recommended by the manufacturer
  - **Grounding**

Never defeat the ground conductor or operate the equipment without a suitably installed ground conductor. Contact the appropriate electrical inspection authority or an electrician if it is uncertain that suitable grounding is available

#### 4.1.2 Installation Checklist



**NOTE:** The iQ 200 Rackmount Satellite Router is designed to be installed in a sheltered environment per environmental specifications. See [Section 2.1, on page 3](#).



**NOTE:** Where applicable, mating connectors must be prepared for installation. See [Appendix C, Cable Preparation on page 29](#) and [Appendix D, DC Power Supply Installation](#) (for routers with DC power supply options, only).

1. Unpack the router according to the unpacking instructions in [Section 4.3, Unpacking iDirect Equipment on page 15](#).
2. Account for all components for the installation. A typical list is given in [Section 4.4, Components Typically Included in an Order on page 16](#).
3. The recommended tools should be available for installation. See [Section 4.2, Tools and Supplies Required for Installation on page 15](#).

4. Prepare the coax cables as directed in [Section C.1, Coax Cable Preparation](#) on page 29 to connect to RX IN and TX Out.
5. Prepare the Ethernet cable(s) and connector(s) as described in [Section C.2, Ethernet Port Pinouts](#) on page 34. For connection to the user interface, use ETH1 port with an RJ-45 cable as described in [Section C.2.2](#), on page 35.
6. If using the Console port for servicing, prepare the console port cable and connector as described in [Section C.3, Console Port Connection](#) on page 35.
7. Mount the router as directed in [Section 4.5, Mounting the iQ 200 Rackmount Satellite Router](#) on page 16.
8. Connect the power as directed for either AC or DC power supplies:
  - See [Section 4.5.1, Installing With an AC Power Supply \(Option 1\)](#) on page 17
  - See [Section 4.5.2, Installing With a 36-76 VDC Power Supply \(Option 2\)](#) on page 17
9. Monitor front and rear panels during startup. See [Section 3.1, iQ 200 Rackmount Satellite Router Front LEDs](#) on page 7 and [Section 3.3, iQ 200 Rackmount Satellite Router Rear Panel Descriptions](#) on page 10.
10. Prepare PC for iQ 200 Rackmount Satellite Router connection as specified in [Section 4.6, Preparing the PC for Connection to the iQ 200 Rackmount Satellite Router](#) on page 18.
11. Login PC to the user interface.
12. Install the firmware and configure the satellite router as specified in [Section 4.7, Configuring the iQ 200 Rackmount Satellite Router](#) on page 18.
13. If the router needs repacking or maintenance see [Chapter 5, Maintenance](#) on page 19.
14. When the iQ 200 Rackmount Router is physically installed, the firmware and configuration of the satellite router needs to be completed. Refer to the *Terminal WUI User Guide* for the release of software installed on the system and for instructions.

## 4.2 Tools and Supplies Required for Installation

[Appendix B, Tools Needed](#) on page 27 specifies recommended tools and supplies used when installing the iQ 200 Rackmount Satellite Router.

## 4.3 Unpacking iDirect Equipment

The satellite router and related equipment may be shipped in one or more shipping containers. Once all of the boxes have been received, perform the following tasks:

- Confirm the boxes are facing upward (refer to the box orientation arrows on the shipping container)
- Inspect all shipping containers
- If any damage or other signs of mishandling are evident, inform the carrier and either iDirect or the reseller
- Remove the tape and any exterior covering from the box lid

Save the iQ 200 Rackmount Satellite Router shipping boxes after unpacking the system. These boxes will be needed in the event of moving or shipping the system in the future. See

[Section 5.5, Repacking the iQ 200 Rackmount Satellite Router on page 22](#) for repacking information.

Remove items from the box only as needed. Verify all of the proper iQ 200 Rackmount Satellite Router components and accessory items listed in the order have been received, including the optional equipment ordered. See [Section 4.4, Components Typically Included in an Order on page 16](#).

## 4.4 Components Typically Included in an Order

Prior to installation, account for all necessary components for a complete VSAT installation. If any items are missing or damaged, contact the Network Operator/Distributor for replacement.

A typical installation includes the following items:

- 1 (one) iQ 200 Rackmount Satellite Router with installed AC or DC power supply
- 2 (two) hardware mounting ear kits
- 1 (one) LAN Ethernet cable
- 1 (one) Quick Start Guide (11 X 17 inch brochure)
- For DC (option 2), 1 (one) connector kit containing: one cable tie, one terminal block plug (P/N Phoenix 1779848), one cable strain relief, P/N 1803947
- Additional components normally required are available in several sizes and types. Consult the iDirect Account Manager for details. The components typically are:
  - One antenna
  - IFL (Inter Facility Link) or coaxial cable appropriate for the installation
  - One appropriate feed assembly for the antenna (OMT)
  - One BUC (Block Up Converter)
  - One LNB (Low Noise Block Converter)

## 4.5 Mounting the iQ 200 Rackmount Satellite Router

This section describes the mounting of the iQ 200 Rackmount Satellite Router. Follow the pre-installation guidelines, see [Pre-Installation Guidelines on page 13](#) before attempting to install.

The iQ 200 Rackmount Satellite Router requires a minimum of one rack unit (1.75 inches) of vertical rack space. Measure the proposed rack location before mounting. If the iQ 200 Rackmount Satellite Router is mounted in an enclosed rack, the router must have adequate ventilation. An enclosed rack should have louvered sides and top with fans to provide cooling air. Before using a particular rack, check for obstructions that could impede installation.

1. All mating connectors must be prepared correctly for installation. See [Appendix C, Cable Preparation on page 29](#) (for all routers) and [Appendix D, DC Power Supply Installation](#) (for routers with DC power supply options, only).
2. Attach the rack ears (included) to the iQ 200 Rackmount Satellite Router with the hardware provided.
3. Mount the iQ 200 Rackmount Satellite Router in the rack.

4. Follow installation procedures for power supply options:
  - Option 1 ([Section 4.5.1, on page 17](#)) for AC power supply
  - Or, Option 2 ([Section 4.5.2, on page 17](#)) for DC power supply

### 4.5.1 Installing With an AC Power Supply (Option 1)

For an iQ 200 Rackmount Satellite Router with an AC power supply Option 1, follow these steps:



**CAUTION:** Direct connections to the power source should only be made by a properly licensed electrician. Installation must meet applicable electrical codes.



**CAUTION:** Improper power source rating, excessive noise or transients, or undersized circuit breaker will result in service interruption.



**CAUTION:** If power must be removed from the chassis, ensure the power cord is disconnected first.



**CAUTION:** The BUC power requirement must match the proper voltage. The BUC may sustain damage when used with incorrect power supply.



**NOTE:** Install an easily accessible socket-outlet near the equipment.

1. First, perform steps 1-6 of the Installation Checklist, [Section 4.1, on page 13](#).
2. Connect the TX and RX coax cables to the iQ 200 Rackmount Satellite Router and secure but do not over-tighten. See [C.1, Coax Cable Preparation on page 29](#) for preparation details.
3. Connect the AC power cord to the power source. This will power ON the iQ 200 Rackmount Satellite Router.
4. Monitor the front and rear panel lights during power on startup. See [Section 3.1, iQ 200 Rackmount Satellite Router Front LEDs on page 7](#).
5. Prepare PC for iQ 200 Rackmount Satellite Router connection as specified in [Section 4.6, Preparing the PC for Connection to the iQ 200 Rackmount Satellite Router on page 18](#).
6. Login PC to the user interface. See [Preparing the PC for Connection to the iQ 200 Rackmount Satellite Router](#).
7. Install the firmware and configure the satellite router as specified in [Section 4.7, Configuring the iQ 200 Rackmount Satellite Router on page 18](#).

### 4.5.2 Installing With a 36-76 VDC Power Supply (Option 2)

For an iQ 200 Rackmount Satellite Router using a 36-76 VDC power supply (Option 2):

1. First, perform steps 1-6 of the Installation Checklist, [Section 4.1](#), on page 13.
2. Set the iQ 200 Rackmount Satellite Router power switch to the OFF position (0).
3. Prepare the power cables per the instructions in [Appendix D, DC Power Supply Installation](#) on page 37 and connect the power cables.



**CAUTION:** The BUC power requirement must match the proper voltage. The BUC may sustain damage if used with the incorrect power supply.

4. Set the iQ 200 Rackmount Satellite Router power switch to the ON position (1).
5. Upon powering up, a Level 0 Reset occurs. Reset options are available in [Appendix E, iQ 200 Rackmount Satellite Router Reset](#) on page 41.
6. Monitor front and rear panel lights during startup. See [Section 3.1, iQ 200 Rackmount Satellite Router Front LEDs](#) on page 7.
7. Prepare PC for iQ 200 Rackmount Satellite Router connection as specified in [Section 4.6, Preparing the PC for Connection to the iQ 200 Rackmount Satellite Router](#) on page 18.
8. Login PC to the user interface. See [Preparing the PC for Connection to the iQ 200 Rackmount Satellite Router](#).
9. Install the firmware and configure the satellite router as specified in [Section 4.7, Configuring the iQ 200 Rackmount Satellite Router](#) on page 18.

## 4.6 Preparing the PC for Connection to the iQ 200 Rackmount Satellite Router

For more information on LEDs, see [Section 3.1, iQ 200 Rackmount Satellite Router Front LEDs](#) on page 7.

Confirm the PC:

- Has a Web browser installed
- Has an IP address that is on the same subnet of the iQ 200 Rackmount Satellite Router
- Includes a Network Interface Card (NIC) connected with a CAT 5 Ethernet cable

## 4.7 Configuring the iQ 200 Rackmount Satellite Router

When the iQ 200 Rackmount Satellite Router is physically installed, the downloading the firmware and configuration of the satellite router need to be completed. For information on installing software packages, see the *Terminal WUI User Guide*. To download the guide, go to <http://tac.idirect.net> and click **Satellite Routers**.



---

---

# 5 Maintenance

This chapter describes the required maintenance procedures for the correct functioning of the iQ 200 Rackmount Satellite Router.

This chapter contains the following sections:

- [Section 5.1, \*Safety Guidelines to Observe During Servicing\* on page 19](#)
- [Section 5.2, \*Maintaining the iQ 200 Rackmount Satellite Router\* on page 20](#)
- [Section 5.3, \*Troubleshooting the iQ 200 Rackmount Router\* on page 21](#)
- [Section 5.4, \*Removing and Replacing the Power Module\* on page 21](#)
- [Section 5.5, \*Repacking the iQ 200 Rackmount Satellite Router\* on page 22](#)

## 5.1 Safety Guidelines to Observe During Servicing



**WARNING:** Do not attempt to service the router internal assemblies, as opening and removing covers may expose personnel to dangerous voltages or other hazards. There are no user serviceable parts inside.

When an iQ 200 Rackmount Satellite Router requires service, observe the safety guidelines in this section.

### 5.1.1 Servicing

Do not attempt to service the iQ 200 Rackmount Satellite Router internal assembly. Opening and removing covers exposes dangerous voltages and/or other hazards. There are no user serviceable parts inside. Opening the units will void the warranty. Refer all servicing to qualified service personnel.

### 5.1.2 Conditions Requiring Service

Disconnect the iQ 200 Rackmount Satellite Router from the power source and refer servicing to qualified service personnel if any of the following conditions occur:

- When the power supply cord or plug is damaged

- If the iQ 200 Rackmount Satellite Router does not operate normally when following the operating instructions (adjust only those controls that are covered by the operating instructions)
- If the iQ 200 Rackmount Satellite Router has been dropped or if the chassis has been damaged
- When the iQ 200 Rackmount Satellite Router exhibits a distinct change in performance

## 5.2 Maintaining the iQ 200 Rackmount Satellite Router

The iQ 200 Rackmount Satellite Router requires basic maintenance to keep it running efficiently and to prolong its life.



**WARNING:** This unit is not serviceable. Return unit to provider for all servicing issues.

**ATTENTION:** Cette unité n'est pas réparable sur site. Renvoyer au fournisseur pour tout réparation.

### 5.2.1 Temperature Control

The iQ 200 Rackmount Satellite Router has a built-in temperature sensor which measures the actual circuit board temperature. If the board temperature exceeds a defined threshold, the iQ 200 PCB shuts down and allows the unit to cool before restarting. See [Table 2-1 on page 3](#), for the proper temperature range.

Elevated internal temperature may be caused by:

- Objects blocking the vent
- Dust accumulated on the enclosure or the vent
- Ambient temperature elevated over the specified limits 90 Day Regular Maintenance

### 5.2.2 90 day maintenance

Typically, the only maintenance needed to be performed on the unit, is to maintain the temperature of the iQ 200 Rackmount Satellite Router and keep its external areas free from moisture, dust or dirt, which are included in a 90-day maintenance cycle.

Perform the following procedures every 90 days:

- Keep the staging area clear and free of dust during and after installation
- Make sure that no objects are blocking the vents
- If there are objects blocking the vents, remove them safely so there is at least 6 inches (15 cm) from the unit
- Make sure that no dust has accumulated on the enclosure or the vent. If dust has accumulated use a soft brush to remove dust
- Make sure that the ambient temperature remains within the specified limits

## 5.3 Troubleshooting the iQ 200 Rackmount Router

Table 5-1 describes the most common iQ 200 Rackmount Satellite Router troubleshooting events and actions. Consult with the iDirect TAC when considering a reset. Reset functions are described in Section E, *iQ 200 Rackmount Satellite Router Reset* on page 41.

Table 5-1. Troubleshooting Events and Actions to Take

Event	Action
Router not functioning	Check status LEDs. Compare LEDs to <a href="#">Table 3-1 on page 8</a>
POWER LED ON and Router not functioning	<p>When the root-cause (external or internal) of the issue in the router is not known, perform the following steps:</p> <ol style="list-style-type: none"> <li>1. Power down and restart the router to see if that resolves the issue.</li> <li>2. When the problem still exists, disconnect the external cabling apart from the power and console cables.</li> <li>3. Connect to the console port and during the boot process, check if the PCB passes the POST boot-up tests.</li> <li>4. Check if the router gets to the login prompt.</li> <li>5. Check if all the option files are in the correct location under <code>/sysopt/config/sat_router</code>.</li> </ol> <p><b>NOTE:</b> Option files varies in each revision of the software.</p> <ol style="list-style-type: none"> <li>6. Check the status LEDs. Compare LEDs to <a href="#">Table 3-1 on page 8</a>.</li> </ol>
Router cannot be accessed by Web User Interface	<p>Router may have a bad options file, settings, or software package.</p> <ol style="list-style-type: none"> <li>1. Power down and restart the router to see if that resolves the issue.</li> <li>2. Perform a Level 2 reset (Boot into Recovery mode) and manually load the correct options file and a software package that is appropriate; and the user interface will be accessed with the default IP address: 192.168.0.1.</li> </ol> <p>See <a href="#">Appendix E, iQ 200 Rackmount Satellite Router Reset</a> on page 41 for more information on Reset.</p>
Lost or forgot IP address of the Router	<ol style="list-style-type: none"> <li>1. Visually check the Ethernet port to ensure there is no physical damage.</li> <li>2. Perform a Level 2 reset (Boot into Recovery mode) so that the iQ 200 Rackmount will have the default IP address: 192.168.0.1. Load new package / options / configuration files with a new IP address, if desired.</li> <li>3. Reboot with a Level 0 reset, and connect with the current / known IP address.</li> </ol> <p>See <a href="#">Appendix E, iQ 200 Rackmount Satellite Router Reset</a> on page 41 for more information on Reset.</p>

## 5.4 Removing and Replacing the Power Module



**WARNING:** Before installing or working on the outdoor equipment, unplug the power cord from the power source. Ensure you always check if power is disconnected.

In the event the Power Module must be removed and/or replaced, [Table 5-2](#) describes the steps to take.

**Table 5-2. Removing and/or Replacing the Power Module**

Event	Steps to Take
Removing the Power Module	<ul style="list-style-type: none"><li>• Make sure power cord is unplugged</li><li>• Unscrew chassis screw</li><li>• Pull firmly but gently on the handle pull of the power supply to extract the power module from the slot</li></ul>
Replacing the Power Module	<ul style="list-style-type: none"><li>• Slide in power supply</li><li>• Make sure the power supply is securely pushed in and flush</li><li>• Tighten screw</li><li>• Plug power cord into power supply input receptacle</li></ul>

## 5.5 Repacking the iQ 200 Rackmount Satellite Router

If the iQ 200 Rackmount Satellite Router system is damaged or if the chassis needs to be moved to another location, the unit needs to be repacked in the original shipping boxes.

**To repack the system:**

1. Disconnect all cables.
2. Place the iQ 200 Rackmount Satellite Router inside the original foam cutout in the shipping box.
3. Properly seal the box with packing tape.

For warranty service, obtain a Return Material Authorization (RMA) number from the reseller or iDirect prior to shipping. Direct customers of iDirect, may contact the iDirect TAC directly to obtain an RMA number and shipping instructions. Follow the shipping instructions, complete the RMA form, and attach the form to the outside of the shipping box.

---

---

# Appendix A Acronyms and Abbreviations

The list in this appendix is meant to be generic and may contain acronyms and abbreviations not found in this manual and some terms may not be defined based on industry standards of knowledge.

## 0...9

16APSK	Sixteen Amplitude and Phase Shift Keying
8PSK	Eight Phase Shift Keying

## A

A-TDMA	Adaptive Time Division Multiple Access
ABS	Automatic Beam Switching
AC	Alternating Current
ACM	Adaptive Coding and Modulation
ACS	Antenna Control System
AES	Advanced Encryption Standard
APSK	Amplitude and Phase-shift keying
AZ	Azimuth

## B

BB	BaseBand
BIM	Below-Decks Interface Module
BIST	Built-In Self-Test
BITE	Built-In Test Equipment
BPN	BUC Part Number
BPSK	Binary Phase Shift Keying

BSN	BUC Serial Number
BTP	Burst Time Plan
BUC	Block Up Converter

## C

C/N	Carrier to Noise ratio
CBIT	Continuous Built In Test
CDR	Critical Design Review
CIR	Committed Information Rate
CPE	Customer Premise Equipment
CPU	Central Processing Unit
CRC	Cyclic Redundancy Check
CSA	Canadian Space Agency

## D

DAC	Digital to Analog Converter
dB	decibel
dB <sub>i</sub>	decibel isotropic
dB <sub>m</sub>	decibel milli-Watt
dBW	decibel Watt
DC	Direct Current
DDR	Double Data Rate

---

DHCP	Dynamic Host Configuration Protocol	<b>I</b>	
DNS	Domain Name Service	IBIT	Initiated Built In Test
	DVB-S2	ICD	Interface Control Document
	Digital Video Broadcasting over Satellite, Second Generation	ICMP	Internet Control Message Protocol
		iDX	Evolution Software System
<b>E</b>		IEC	International Electro-technical Commission
EIRP	Effective Isotropic Radiated Power	IFL	Inter-Facility Link
Eb/NO	Bit Energy to Noise Power Spectral Density ratio	IF	Intermediate-frequency
EEPROM	Electrically Erasable Programmable Read-Only Memory	IP	Ingress Protection
		IP	Internet Protocol
EL	Elevation	IR	Information Rate
EMC	ElectroMagnetic Compatibility		
EMI	ElectroMagnetic Interference	<b>J</b>	
ETSI	European Telecommunications Standards Institute		
		<b>K</b>	
<b>F</b>		kbps	kilobit per second
FCC	Federal Communication Commission	kHz	kilohertz
FEC	Forward Error Correction	KRFU	Ku/Ka-band Radio Frequency Unit
FID	Functional ID	ksps	kilosymbol per second
FMECA	Failure Mode Effects Criticality Analysis		
FPGA	Field Programmable Gate Array	<b>L</b>	
FS	Functional Specification	LAN	Local Area Network
		LDPC	Low-Density Parity Coding
		LED	Light Emitting Diode
<b>G</b>		LNB	Low Noise Block Converter
G/T	Gain over Temperature	LOS	Loss of Signal
GHz	GigaHertz	LRU	Line-Replaceable Unit
GPIO	General-Purpose Input/Output		
GPS	Global Positioning System	<b>M</b>	
		Mbps	Megabits per second
<b>H</b>		Mcps	Megachips per second
HCP	High-Capacity Payload	MES	Mobile Earth Station
		MF-TDMA	Multi-Frequency TDMA

---

MHz	Megahertz	<b>Q</b>	
MID	Manufacturer ID	QEF	Quasi Error Free
MIL-STD	US Military Standard	QoS	Quality of Service
MODCOD	Modulation and Coding	QPSK	Quadrature Phase Shift Keying
MspS	Mega Symbols per Second		
MTBF	Mean Time Between Failures	<b>R</b>	
MTBUR	Mean Time Between Unscheduled Removals	RF	Radio Frequency
		RGMI	Reduced Gigabit Media Independent Interface
<b>N</b>		RMS	Root Mean Square
NAND	Not AND	RoHS	Restriction of Hazardous Substances
NF	Noise Figure	ROM	Read-Only Memory
NOR	Not OR	RSSI	Receive Signal Strength Indication
NMS	Network Management System	RTP	Real-Time Protocol
		Rx or RX	Receive
<b>O</b>			
OAE	Outside Antenna Equipment	<b>S</b>	
ODU	Outdoor Unit	SAS	Satellite Access Station
OEM	Original Equipment Manufacturer	SCPC	Single Channel Per Carrier
OMT	Orthogonal-Mode Transducer	SGMI	Serial Gigabit Media Independent Interface
OpenAMIP	Open Antenna-Modem Interface Protocol	SIM	Subscriber Identity Module
OTA	Over The Air	SNR	Signal to Noise Ratio
OTP	One Time Programmable	SRS	Systems Requirement Specification
		SRU	Shop Replaceable Unit
<b>P</b>		SSB	Single Side Band
PA	Power Amplifier		
PAST	Person-Activated Self-Test	<b>T</b>	
PCB	Printed Circuit Board	TBD	To Be Defined
PC	Personal Computer	TCP	Transmission Control Protocol
PDR	Preliminary Design Review	TDMA	Time Division Multiple Access
PLL	Phased Locked Loop	TFI	Terminal Functional ID
PSK	Phase Shift Keying	TMI	Terminal Manufacturer ID
PSU	Power Supply Unit	TPCFEC	Turbo Product Code FEC
		TPN	Terminal Part Number

---

---

---

TSN	Terminal Serial Number
TTC	Terminal Transmit Control
Tx or TX	Transmit

## **U**

UDP	Universal Data Protocol
UL	Underwriters Laboratories

## **V**

VAC	Volts Alternating Current
VDC	Volts Direct Current
VSAT	Very Small Aperture Terminal

## **W**

WFQ	Weighted Fair Queuing
WGS	Wideband Global SATCOM

## **X**

## **X**

## **Z**



---

---

# Appendix B Tools Needed

Figure B-1 and Table B-1 specify recommended tools and supplies for a typical installation. Additional tools and equipment may be required to install related equipment and cables. Test equipment may be required to check signal, power levels, and communication links.



Figure B-1. Recommended Installation Tools

Table B-1. Recommended Installation Tools and Equipment

Quantity	Tool
1	Number 2 Phillips screwdriver
1	F-type Compression Tool
1	RG-6 Coax Stripper
1	Coax / Wire Cutter
Length as Needed	RG-6 or RG-11 solid copper conductor coax outdoor rated cable



---

---

# Appendix C Cable Preparation

This appendix describes the cable preparation details and has these sections:

- [Section C.1, Coax Cable Preparation on page 29](#)
- [Section C.2, Ethernet Port Pinouts on page 34](#)
- [Section C.3, Console Port Connection on page 35](#)

## C.1 Coax Cable Preparation



**NOTE:** The procedures in this section, for preparing coaxial cables, are meant to be generic. Cables and connectors should be installed per manufacturer's requirements specific to the brands preferred. In general, specific and detailed instructions are for RG-6 cables and connectors, only.

Use high quality coaxial outdoor cable to connect the iQ 200 Rackmount Satellite Router to the Outdoor Unit (ODU) equipment. iDirect recommends that a solid copper center conductor, coaxial cable be used with a minimum of 60% + 40% braid and double foil shield to connect the equipment, such as:

- RG-6 – 0.04 inch (1 mm), outdoor rated, Quad Shielded, solid bare copper center conductor, for cable lengths less than or equal to 225 feet (68.5 meters)
- RG-11 – 0.064 inch (1.6 mm), outdoor rated, Quad Shielded, solid bare copper center conductor, for cable lengths less than or equal to 400 feet (121.9 meters)

Before connecting the cables, connectors on each end must be installed.

The center conductor must be straight and extend 1/8 inch (3.2 mm) beyond the end of the F-connector, and the connector should be securely crimped to the cable.



**NOTE:** iDirect does not recommend using RG-59 with solid bare copper center conductor. RG-6 or RG-11 Quad Shield or other outdoor quality, 75-ohm type of coax can be used.

If different types of coaxial cable are used other than the recommended quad shield RG-6, the following problems can occur:

- **Co-channel Interference** - If signals at the same frequency are carried on long, parallel runs of coaxial cable (for example, in cable trays, or riser) interference can occur between the signals
- Higher quality cable helps to prevent this with better shielding

- Co-channel interference causes degradation and higher packet loss rate
- **Good return loss** - High quality cable and correct connectors help ensure an optimal return loss of 10 dB or more



**NOTE:** Excessive DC Resistance - will result in excessive voltage drop across the IFL cable. Hence, the voltage at the BUC may be too low to operate properly.



**NOTE:** [Appendix B, Tools Needed on page 27](#) lists all of the recommended tools for terminating coax cables.

**To terminate the cables with F-Type connectors:**

1. Cut off each end of the coax cable squarely, using the proper cable cutter as shown in [Figure C-1](#).

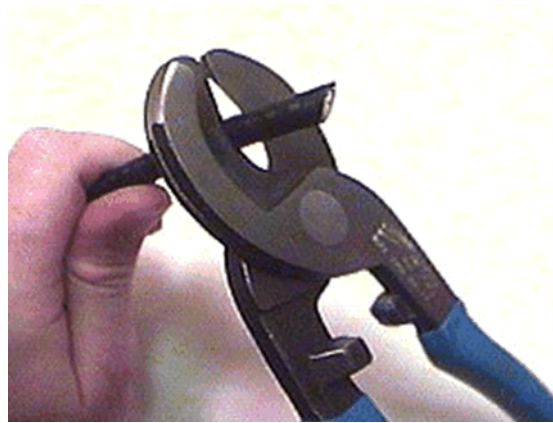

**Figure C-1. Coax Cable Cutting Technique**



**WARNING:** Wear protective eye wear while cutting cables and terminating connectors.



**WARNING:** The center conductor must be straight and cylindrical without any burrs. Failure to do so can damage the satellite router, BUC, and/or LNB input connector.

2. Remove the jacket material and foam insulation according to the length defined under **Length A** in [Table C-1](#). For RG-6, use a two-step Coax Stripper such as the LC-CST 1257 from Paladin Tools.

**Table C-1. Coax Trim Dimensions**

	<b>Length A</b> (inch (mm))	<b>Length B</b> (inch (mm))	<b>Length C</b> (inch (mm))
RG-6	5/8 (15.9)	1/4 (6.4)	3/8 (9.5)

Table C-1. Coax Trim Dimensions

RG-11	13/32 (10.3)	3/32 (2.4)	13/32 (10.3)
-------	--------------	------------	--------------

3. Remove any foil in the braid as shown in [Figure C-2](#).



Figure C-2. Cutting Technique for Removing Foil in the Braid

4. Fold the braid back over the jacket and trim the braid to the length as defined under **Length C** in [Table C-1](#) on page 30 and shown in [Figure C-3](#).

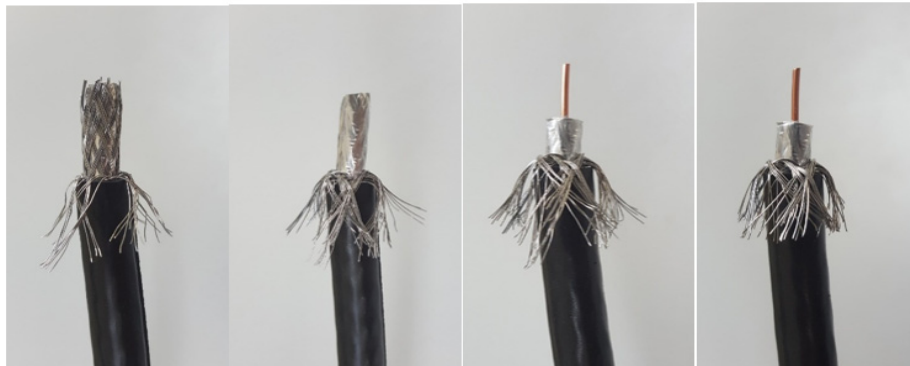
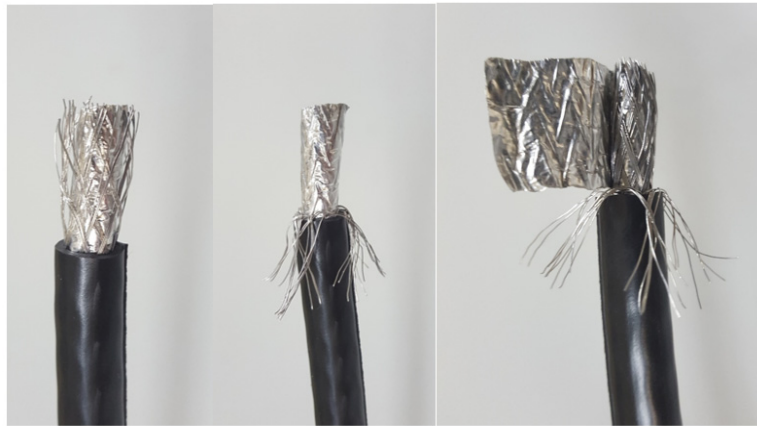

**Figure C-3. Procedure to Cut the Quad Shield Cable**

5. Flare the inner, outer braids and the outer foil shield only. Do not flare the inner foil shield (last foil around dielectric).
6. (If using a coax stripper, skip this step.) Being careful not to cut into the copper of the center conductor, remove the foil and cut the dielectric to the length shown under **Length B** in [Table C-1](#) on page 30. Remove any dielectric residue.
7. If the conductive foil is burred, then smooth out the burr so that the edge (area where the dielectric material was removed) is smooth and provides a lead-in for the connector mandrel.
8. Install the RG-6 connector compression sleeve, or mandrel, (top left (A) in [Figure C-4](#)) over foil and underneath the braid. A good, weatherproof outdoor connector mandrel should have a visible O-Ring (bottom right (B) [Figure C-4](#)).



**NOTE:** The white colored inner dielectric insulation should be flush with the inner rear surface of the connector. Refer to the picture on the right (C) in [Figure C-4](#) for an RG-6/RG-11 termination.



**NOTE:** Since the RG-11 connector has a built-in center pin, ensure that the coax center pin makes contact to the internal seizing pin of the connector. Refer to Figure C-4.

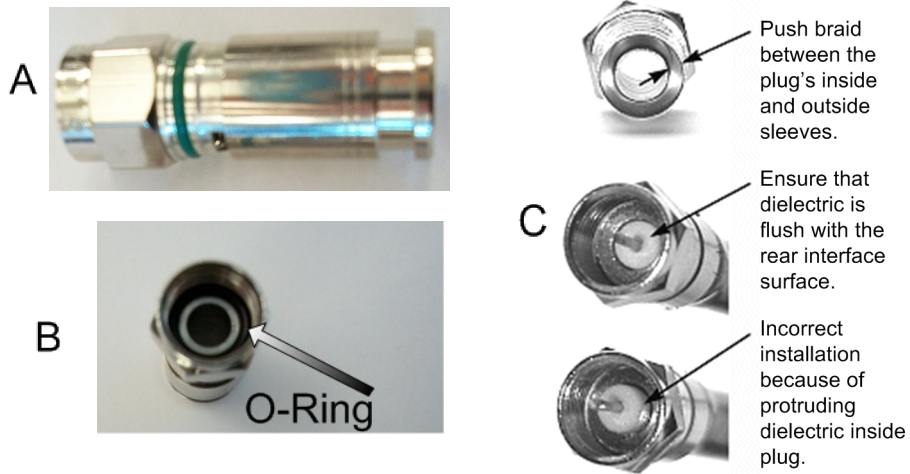

Figure C-4. Attaching the Compression fitting F-type Connector

9. Finish connecting the cable to the connector with the compression tool connector, such as Holland Compression Tool 1855 as shown in Figure C-5.



Figure C-5. Compression fitting F-Type Weatherproof Plug and Tool

10. Inspect and ensure that the copper center conductor only protrudes 1/8 inch (3.2 mm) nominally beyond the rim of the F-connector. Trim if necessary.



**CAUTION:** The center conductor length must be a minimum of 1/16 inch (1.6 mm) to a maximum of 1/8 inch (3.2 mm) protrusion beyond the rim of the F type connector. It must be straight and cylindrical without any burrs at the end. Failure to follow this technique could result in damage to the satellite router, BUC, LNB connector and/or possible intermittent service.

## C.2 Ethernet Port Pinouts

The Ethernet cable included in the order is typically a straight through cable typically used for connection to a PC. The iQ 200 Rackmount Router is capable of Universal Cable Recognition or auto-MIDX (auto-sensing) and will connect to a PC with the straight through Ethernet cable for using the user interface.

LAN 1 port is the recommended port to connect the Ethernet cable to the Ethernet port on the PC running the user interface.

Either crossover or straight through cables may be used with the iQ 200 Rackmount Router. It is not necessary for the PC to auto-sense. Details of the iQ 200 Rackmount Router LAN/Ethernet port pinouts are described in [Section C.2.1](#) and [Section C.2.2](#) defines straight through and crossover cables.

### C.2.1 Ethernet Port Pinouts

[Table C-2](#) lists the pinouts for the Ethernet ports (labeled LAN 1-2) of the iQ 200 Rackmount Router and the pinout order is shown in [Figure C-6](#).

Table C-2. Ethernet Port Pinouts

RJ-45 Pin	Description
1	Tx+
2	Rx+

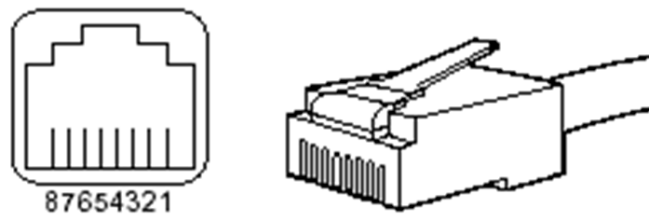

Figure C-6. RJ-45 Cable Connectors: Receptacle and Plug

The 10 Base-T/100 Base-T Fast Ethernet ports support IEEE 802.3 and IEEE 802.3u specifications for the 10-Mbps and 100-Mbps transmission over Unshielded Twisted-Pair (UTP) cables. Use Category-3 or Category-5 UTP cable with RJ-45 connectors to attach the 10/100 Base-T Ethernet LAN ports on the iQ 200 Rackmount Satellite Router chassis to the customer provided LAN Hub or switch.



**NOTE:** iDirect supplies one 7-foot Category 5 UTP cable to connect the iQ 200 Rackmount Router to the LAN hub or switch. If additional cables or different lengths are needed, they may be bought commercially.



### C.2.2 Straight Through and Crossover RJ-45 Cables

To confirm the RJ-45 cable type, hold the cable ends as depicted in [Figure C-7](#). The sequence of the colored wires should be as follows:

- Straight through – The colored wires are in the same sequence at both ends of the cable
- Crossover – The first (far left) colored wire at one end of the cable is the third colored wire at the other end of the cable, and the second colored wire at one end of the cable is the sixth colored wire at the end of the cable

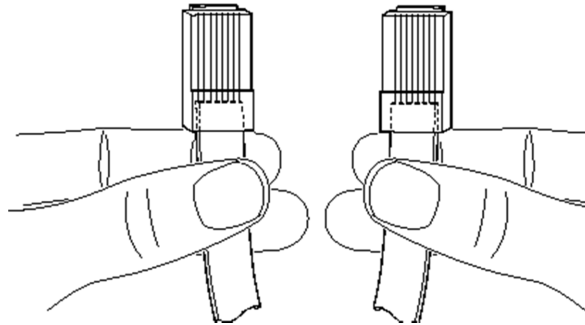

Figure C-7. Holding the RJ-45 Cable Connectors

## C.3 Console Port Connection

The Console port is used for servicing the iQ 200 Rackmount Router.

Connect as follows:

1. Connect an RJ-45 to RJ-45 straight through cable, such as the Ethernet cable included, to LAN 1 port on the iQ 200 Rackmount Router.
2. Connect the opposite end of the Ethernet cable to an RJ-45 to DB-9 female DTE adapter, or a USB dongle (such as a Trendnet TU-S9).
3. Connect to a PC running terminal emulation software.

PC serial port settings should be:

- asynchronous mode
- 115200 baud
- eight (8) data bits, no (N) parity bit, and one (1) stop bit, (115200/8-N-1)

The signal and pinouts for the asynchronous serial **Console** port (RS-232) of the iQ 200 Rackmount Router and an RJ-45 to DB-9 female DTE adapter are listed in [Table C-3](#). A picture of the RJ-45 to DB-9 Female DTE adapter is shown in [Figure C-8](#) on [page 36](#).

Table C-3. RJ-45 to DB-9 Pinouts

Console Port (DTE)	RJ-45 Pin	Color Code	RJ-45 to DB-9 Terminal Adapter	Console Device
RTS	1	Blue	8	CTS

Table C-3. RJ-45 to DB-9 Pinouts

Console Port (DTE)	RJ-45 Pin	Color Code	RJ-45 to DB-9 Terminal Adapter	Console Device
DTR	2	Orange	6	DSR
TxD	3	Black	2	RxD
GND	4	Red	NC	GND
GND	5	Green	5	GND
RxD	6	Yellow	3	TxD
DSR	7	Brown	4	DTR
Rx-RF-Power	8	White/Grey	9	Not Connected

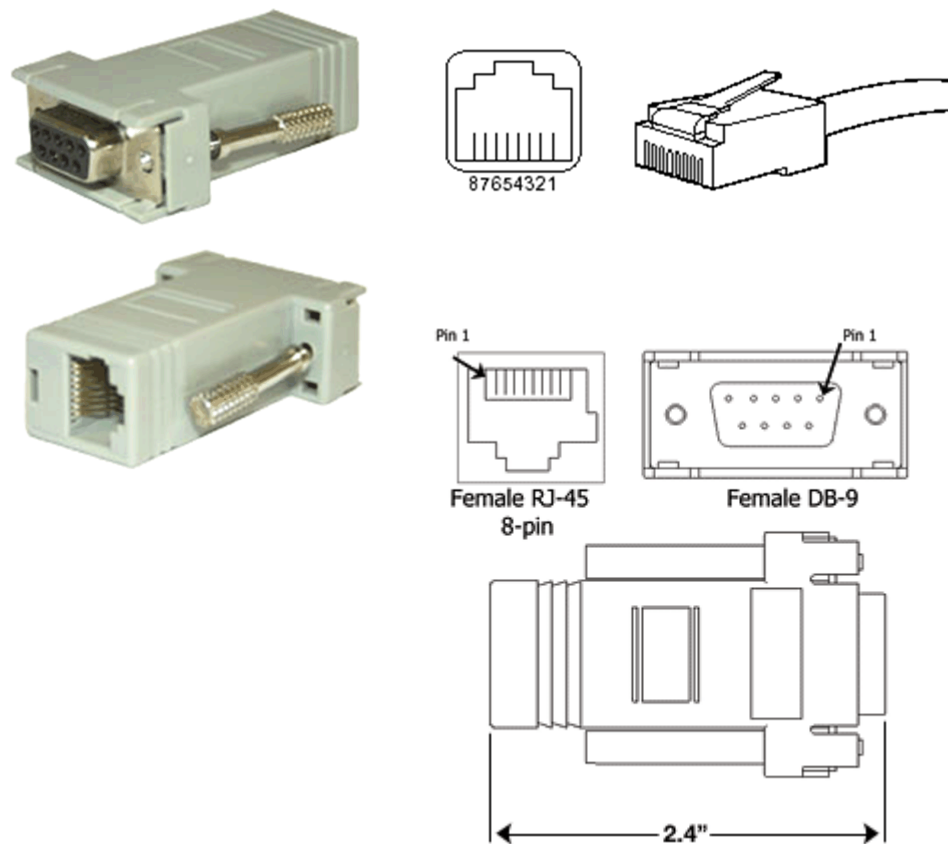

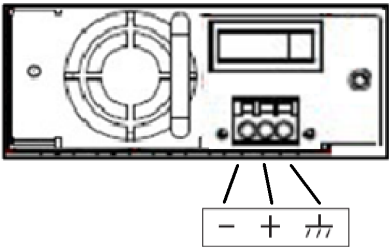

Figure C-8. RJ-45 to DB-9 Female DTE Adapter

# Appendix D DC Power Supply Installation

This appendix describes the installation of the DC power supply wiring for Option 2.

Make sure all items are available to prepare the cable entry housing. Descriptions and diagrams of the items included with the router or necessary for the DC wiring are found in [Table D-1](#). “At a Glance” instructions are in [Figure D-1 on page 38](#) with corresponding detailed steps in [Table D-2 on page 38](#).

**Table D-1. iQ 200 Rackmount Router DC Power Module Connector Parts**

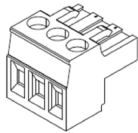
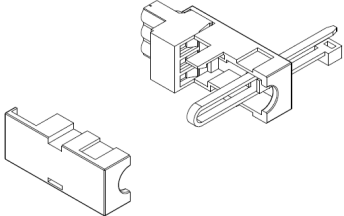
Name	Description	Diagram or Reference
DC Terminal block	Rear panel, DC terminal block area	
3 DC input wires	Appropriately labeled wires, such as: <ul style="list-style-type: none"> <li>• red = positive +</li> <li>• black = negative -</li> <li>• blue = ground - </li> </ul>	14-18 AWG (American Wire Gauge) Reference: <a href="http://en.wikipedia.org/wiki/American_wire_gauge">http://en.wikipedia.org/wiki/American_wire_gauge</a>
Terminal block plug	Included in kit, P/N Phoenix 1779848	
Cable Entry Housing Strain Relief and Cable Tie	Cable Entry Housing Strain Relief and Cable Tie, included in kit, P/N 1803947, and cable tie	

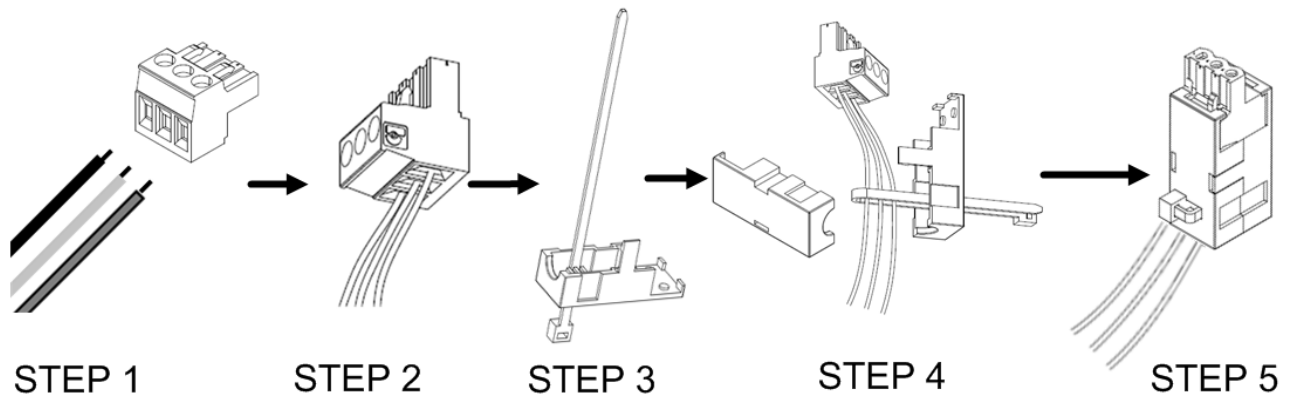

**Figure D-1. DC-DC Power Supply Assembly at a Glance**

DC-DC Power Supply Assembly at a Glance

**Table D-2. Power Module Power Cable Installation Instructions Detail**

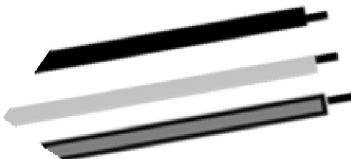
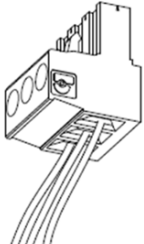
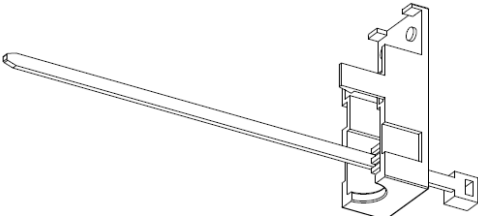
Step	Instructions	Diagram
1.	Strip approximately 1/4 inch of insulation from the ends of three appropriately sized (14-18 AWG) DC input wires.	
2.	Loosen the three screws on the terminal block plug. Insert DC (-), DC (+), and ground wires into the corresponding terminals of the DC terminal block plug. Fasten the three screws securely. Do not over-tighten.	
3.	Insert the cable tie through one of the holes in the right half of the strain relief clip.	

**Table D-2. Power Module Power Cable Installation Instructions Detail**

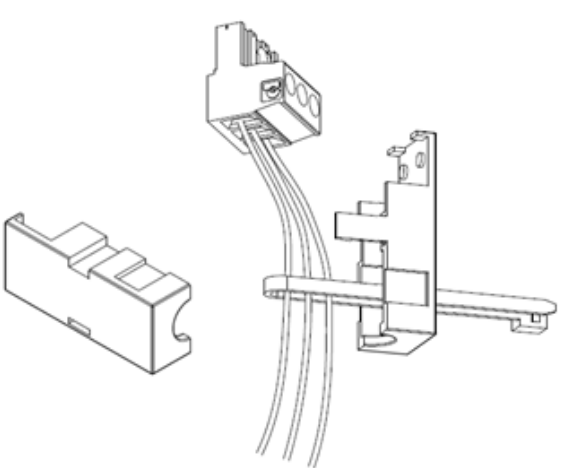
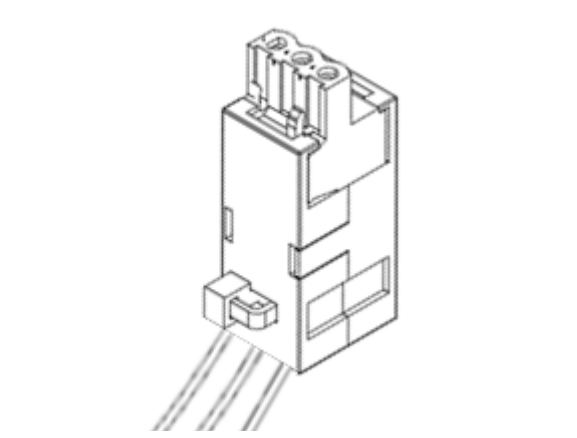
Step	Instructions	Diagram
4.	<ol style="list-style-type: none"><li data-bbox="289 342 836 394">1. Wrap the cable tie around the wires, and tighten.</li><li data-bbox="289 394 836 520">2. Insert the “three screw end” of the terminal block plug into the half of the strain relief clip. Be sure the two end screw holes fit securely into the two small protruding screw holders.</li></ol>	
5.	<ol style="list-style-type: none"><li data-bbox="289 825 836 898">1. Clip the other half of the strain relief clip around the cable entry housing and tighten the cable tie.</li><li data-bbox="289 898 836 1003">2. Insert the finished terminal block plug, with the cable entry housing, into the terminal block header in the power supply.</li></ol>	



---

---

# Appendix E iQ 200 Rackmount Satellite Router Reset

The iQ 200 Rackmount Satellite Router has two types of reset functions: Level 0, and Level 1. Each type has a different effect on the router. Contact the iDirect TAC center for more information.



**NOTE:** Refer to the *Terminal WUI User Guide* for more information. It is good practice to clear browser history, and turn off Web page caching, before accessing the user interface.

## E.1 Level 0 Reset

Level 0 reset provides a basic reset function with the following features:

- Initiated by:
  - Router powering up
  - Briefly pressing the reset button for 10 seconds or less. See [Section 3.3, iQ 200 Rackmount Satellite Router Rear Panel Descriptions on page 10](#) for the reset button location
  - In the user interface, select the **Administration > Software and Configuration > Reboot Terminal**
- Used to boot to a newly-loaded software image and configuration
- Recovery: initiate a Level 0 reset

## E.2 Level 1 Reset

Level 1 reset provides a means of returning the router to factory default settings.



**NOTE:** This reset must not be used unless there is an intent to reconfigure or reload the software and options. There is no recovery once this reset occurs. New options file, software, and configuration must be loaded using the Terminal WUI once this reset has been initiated.

Level 1 reset features:

- Initiated by: Pressing the reset button and keeping it pressed for more than 10 seconds, see [Section 3.3, iQ 200 Rackmount Satellite Router Rear Panel Descriptions on page 10](#) for the reset button location

## *Level 1 Reset*

---

- Intended for recovery of the remote only, and new options file, configuration, and software must be loaded
- Router boots with factory default image (default options file, software, and passwords), access to Terminal WUI is available at the Management port ETH 2 at 192.168.0.1
- Recovery: none - reload software, options file, configuration





**iDirect**

13861 Sunrise Valley Drive, Suite 300

Herndon, VA 20171-6126

+1 703.648.8000

+1 866.345.0983

[www.idirect.net](http://www.idirect.net)

*Advancing a Connected World*