

Sea Tel Dual Antenna Arbitrator (MXP systems) Installation Manual

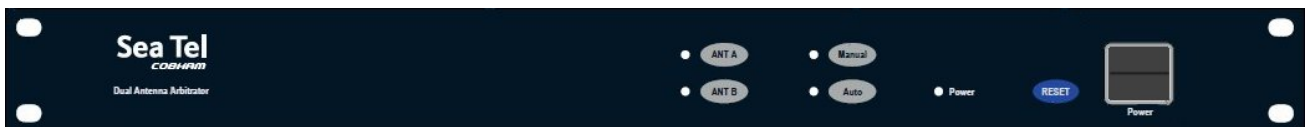

Sea Tel, Inc.
(trading as Cobham SATCOM)
4030 Nelson Avenue
Concord, CA 94520
Tel: +1 (925) 798-7979
Fax: +1 (925) 798-7986

Sea Tel
COBHAM

Thrane and Thrane A/S
(trading as Cobham SATCOM)
Lundtoftegaardsvej 93 D, 2800 Kgs.
Lyngby, Denmark
Tel: +45 3955 8800
Fax: +45 3955 8888

Web: <http://www.cobham.com/satcom>

Email: satcom.ohc@cobham.com

Dual Antenna Arbitrator (MXP)



These commodities, technology, or software were exported from the United States in accordance with the Export Administration Regulations. Diversion contrary to U.S. law is prohibited.



Sea Tel Marine Stabilized Antenna systems are manufactured in the United States of America.



Sea Tel is an ISO 9001:2008 registered company. Certificate Number 13690 originally issued on March 14, 2011 and renewed / reissued on March 10, 2014.

**R&TTE
CE**

The Sea Tel Media Xchange Point™ (MXP) Antenna Control Unit, used with this Sea Tel Dual Antenna Arbitrator and the Sea Tel Antenna complies with the requirements for Radio and Telecommunication Terminal Equipment. A copy of the R&TTE Declaration of Conformity for this equipment is contained in the Antenna Manual for your system.



The Sea Tel Media Xchange Point™ (MXP) Antenna Control Unit, used with this Sea Tel Dual Antenna Arbitrator, contains FCC compliant supervisory software to continuously monitor the pedestal pointing accuracy and use it to control the “Transmit Mute” function of the satellite modem to satisfy the provisions of FCC 47 C.F.R. § 25.222(a)(l)(iii). A copy of the FCC Declaration of Conformity for this equipment is contained in the Antenna Manual for your system.

Copyright Notice

Copyright © 2015 Sea Tel Inc. All Rights Reserved.

The information contained in this document is proprietary to **Sea Tel**, Inc. This document may not be reproduced or distributed in any form, without prior written consent of **Sea Tel**, Inc. The information in this document is subject to change without notice. **Sea Tel** Inc. is also doing business as Cobham SATCOM.

Revision History

REV	ECO#	Date	Description	By
A		August 6, 2015	Production Release	MDN

Cobham SATCOM
Marine Systems, Sea Tel Products
4030 Nelson Ave., Concord
California, 94520 USA

Tel: +1 (925) 798-7979
Fax: +1 (925) 288-1420

European Union Declaration of Conformity

Doc Number 134921 Revision A

Sea Tel Inc. declares, under our sole responsibility, that the products identified below are in conformity with the requirements of:

DIRECTIVE 1999/5/EC of the European Parliament and of the Council of 15 March 2004 on Radio equipment and Telecommunication Terminal Equipment and the mutual recognition of their conformity.

Product Names:

Arbitrator - Sea Tel

These products have been assessed to Conformity Procedures, Annex IV, of the above Directive by application of the following standard(s):

EMC:

Marine Navigational and Radio Communication
Equipment and Systems – General Requirements: **IEC/EN 60945:2002 + Corr 1:2008**

Conducted Emissions, Clauses 9.2
Radiated Emissions, Clauses 9.3
Electrostatic discharge, Clause 10.9 and IEC 61000-4-2 §5
Continuous Radiated Disturbances, Clause 10.4
Fast Transients Bursts, Clause 10.5.2, and IEC 61000-4-4 §5
Surges EN, Clause 10.6, and EN 61000-4-6: ED 2
Continuous Conducted Disturbance, Clause 10.3, and IEC 61000-4-6 §5
Power Supply Failure, Clause 10.8 Further information in IEC 61000-4-6: ED 3

SAFETY:

Safety of Information Technology Equipment: **IEC/EN 60950-1:2006 + A1:2010**

Certificates of Assessment were completed and are on file at BACL- Bay Area Compliance Laboratories, Sunnyvale, CA 94089

Sea Tel, Inc
Concord, CA

Peter Blaney, Chief Engineer

6/3/11
Date

1. INTRODUCTION	1-1
1.1. DUAL ANTENNA CONFIGURATION	1-1
1.2. DUAL ANTENNA ARBITRATOR	1-1
1.3. AUTOMATIC BEAM SWITCHING (ABS)	1-1
1.4. OPENAMIP™	1-1
1.5. FCC COMPLIANCE	1-2
2. FRONT PANEL OPERATION	2-1
2.1. FRONT PANEL BUTTONS	2-1
2.2. FRONT PANEL LEDs	2-1
2.3. AUTOMATIC MODE	2-1
2.4. MANUAL MODE	2-2
3. REMOTE OPERATION	3-1
3.1. AUTOMATIC BEAM SWITCHING (ABS)	3-1
3.2. OPEN ANTENNA-MODEM INTERFACE PROTOCOL (OPENAMIP™) SPECIFICATION:	3-1
3.2.1. Overview:	3-1
3.2.2. Interface requirements:	3-2
3.3. DUAL ANTENNA ARBITRATOR COMMAND SUMMARY	3-2
3.3.1. Command Details	3-3
3.3.2. General Notes	3-5
4. DUAL ANTENNA INSTALLATION	4-1
4.1. UNPACKING AND INSPECTION	4-1
4.2. INSTALL THE DUAL ANTENNA ARBITRATOR	4-1
4.3. SHIPBOARD CABLE INSTALLATION	4-1
4.4. CONNECTING THE BELOW DECKS EQUIPMENT	4-1
4.5. DUAL ANTENNA ARBITRATOR CONNECTIONS	4-4
4.6. MXP CONNECTIONS	4-4
4.7. SET-UP	4-5
4.7.1. IP Address Setting	4-5
4.7.2. MXP Tracking Settings	4-5
4.7.3. MXP Targeting	4-5
4.7.4. MXP Blockage Zones	4-5
4.7.5. Balancing TX Output	4-5
4.8. TESTING ARBITRATOR SWITCHING	4-5
5. SETUP	5-1
5.1. DEFAULT PARAMETER SETTINGS:	5-1
5.2. BALANCING TX OUTPUT	5-1
6. FUNCTIONAL TESTING	6-1
6.1. TEST DUAL ANTENNA ARBITRATOR - MANUAL MODE	6-1
7. TROUBLESHOOTING & MAINTENANCE	7-1
7.1. ISOLATING IF & RF PROBLEMS:	7-1
7.2. GPS PROBLEMS:	7-1
7.3. NETWORK LOCK PROBLEMS:	7-1
7.4. TX MUTE PROBLEMS:	7-2
8. SLIDE RAIL KIT (OPTIONAL) INSTALLATION	8-1
8.1. ASSEMBLING THE OUTER RAILS	8-1
8.2. MOUNTING THE OUTER RAILS IN THE RACK	8-1
8.3. MOUNTING THE INNER RAILS	8-1
8.4. MOUNTING THE ARBITRATOR INTO YOUR RACK	8-1
9. SPECIFICATIONS	9-1
9.1. GENERAL	9-1
9.2. FRONT PANEL	9-1

9.3. REAR PANEL.....9-1

 9.3.1. AC POWER9-1

 9.3.2. Switch Plate - Standard Low Power9-1

 9.3.3. Switch Plate - 10 MHz Option9-2

 9.3.4. Switch Plate - High Power Option9-3

9.4. COMPLIANCE.....9-4

9.5. ENVIRONMENTAL CONDITIONS.....9-4

10. DRAWINGS..... 10-1

 10.1. DUAL ANTENNA ARBITRATOR DRAWINGS..... 10-1

1. Introduction

The Dual Antenna Arbitrator is to be used with two complete Sea Tel Transmit/Receive (TX/RX) satellite communication systems. The primary purpose of the Dual Antenna Arbitrator is to switch services from one antenna, which has become blocked by the ships structure or has otherwise lost service, to the other antenna. Switching services to the satellite modem under these conditions greatly improves on-air time by reducing the out of service time.

Additionally, this device allows for remote monitor, control and diagnostics directly or with Out of Band Management (OBM) device(s).

1.1. Dual Antenna Configuration

Sometimes, due to very large blockage conditions, you may need to install a dual antenna configuration to provide virtually uninterrupted services. Two full antenna systems are installed and the two ACU control outputs are connected to a dual antenna arbitrator switch panel which then is connected to the satellite modem, and other below decks equipment if provided. Refer to the appropriate installation chapter for the model of the Sea Tel antenna systems that you will be installing this arbitrator panel with.

You will program the blockage zone(s) and optimize all other settings for best “on-satellite” performance for each of the two Sea Tel antennas.

The following signals pass through the arbitrator to/from the ACU’s and the Satellite Modem:

- TX IF signal to the active (selected) antenna from the Satellite Modem. 10 MHz reference is also passed when provided by the modem.
- RX IF from the active (selected) antenna to the Satellite Modem
- Blockage control output from each ACU – this output provides signal to the arbitrator when the antenna it is connected to is not available for services.
- GPS position - output from the active (selected) antenna (this setting can be changed in the arbitrator).
- Network Lock signal from the Satellite Modem is routed to both ACU’s to enable both antennas to track the same satellite.

When one antenna is blocked, its blockage output will command the arbitrator panel to switch services for the modem from that antenna to the other antenna. The arbitrator panel provides a logic latch to prevent excess switching when the ship heading is yawing, therefore, causing either antenna to be repeatedly blocked – unblocked – blocked.

1.2. Dual Antenna Arbitrator

The Dual Antenna Arbitrator panel automatically switches the signal from one of the two antennas. It can pass LNB voltages (and handle 250-400 ma of current) and all of the typical RX IF and M&C signals on the RX connections.

DC Voltage to power the BUC(s) should **NOT** be passed through this arbitrator panel, nor the dual channel coax rotary joint of the antenna pedestal. BUC power should be supplied on the Antenna Pedestal.

TX IF and Reference signals can be passed through the dual antenna arbitrator.

The blockage (SW2) output, GPS output and Modem lock input from the two terminal mounting strips (antenna “A” and antenna “B”) are wired through the arbitrator panel to the satellite modem. When antenna “A” is blocked, the arbitrator PCB will toggle the coax switches so that antenna “B” provides signal to the satellite modem. When antenna “A” is no longer blocked the arbitrator will do nothing (because it is a latch circuit). When antenna “B” is blocked the panel will switch so that antenna “A” is again providing signal the BDE distribution.

To provide a seamless switching transition, refer to the arbitrator installation instructions to balance the TX & RX signal levels between the two antennas.

1.3. Automatic Beam Switching (ABS)

ABS is a method of communicating remotely via an overhead channel, or locally from the modem, to reconfigure the ACU(s) to use a different beam on the same satellite or to use a different satellite. The ACU’s include commands which allow remotely setting all of the necessary parameters and to command the targeting of the desired satellite.

1.4. OpenAMIP™

OpenAMIP™ is a standardized language incorporated into the current iDirect modems which communicates automatic beam switching settings from the option file to the Sea Tel ACU(s). This allows the network to accomplish to provide automatic beam switching remotely by switching option files in the remote modem.

1.5. FCC Compliance

FCC regulation 47 C.F.R. § 25.221 (C-Band) and 47 C.F.R. § 25.222 (Ku-Band) define the provisions for blanket licensing of ESV antennas operating in the C, and Ku, Band respectively. Please refer to the FCC Declaration in your antenna manual for specifics.

The Sea Tel antennas referenced in this document, will maintain a stabilization pointing accuracy of better than 0.2 degrees under specified ship motion conditions.

These antenna systems, with current software, contain FCC compliant supervisory software to continuously monitor the pedestal pointing error. This supervisory software will trip an error flag, which will automatically cease transmission within 100 milliseconds, if the pointing error should exceed 0.5 degrees. Transmission will not resume until the pointing error drops below 0.2 degrees.

To be compliant with these FCC requirements, the “Transmit Mute” output of the Sea Tel below decks controller must be connected, through the Dual Antenna Arbitrator, to the “Mute Input” of the satellite modem via serial or Ethernet connection.

2. Front Panel Operation

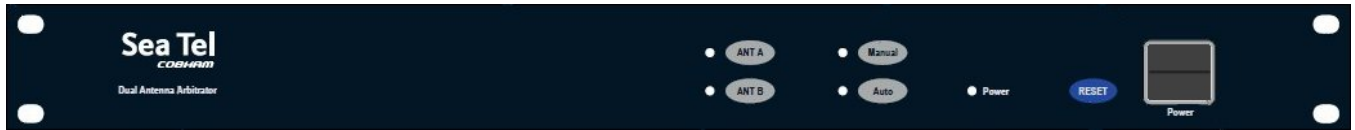

2.1. Front Panel Buttons

ANT A - In Manual Mode this button selects Antenna “A” to be the “Active” antenna. The TX & RX IF signals from Antenna “A” are routed to the Satellite Modem via the Arbitrator coax switches. Antenna “B” is the “Standby” antenna.

ANT B - In Manual Mode this button selects Antenna “B” to be the “Active” antenna. The TX & RX IF signals from Antenna “B” are routed to the Satellite Modem via the Arbitrator coax switches. Antenna “A” is the “Standby” antenna.

Manual - Selects Manual Mode.

Auto - Selects Automatic Mode.

RESET - Resets the processors in the Dual Antenna Arbitrator

Power - Turns the Dual Antenna Arbitrator ON/OFF. When OFF, the de-energized state of the coax switches is Antenna “A”. When energized, the default power-up state in **Auto** – **ANT A**.

2.2. Front Panel LEDs

ANT A - When illuminated, this LED indicates that Antenna “A” is the “Active” antenna.

ANT B - When illuminated, this LED indicates that Antenna “B” is the “Active” antenna.

Manual - When illuminated, this LED indicates that the Dual Antenna Arbitrator is in Manual Mode.

Auto - When illuminated, this LED indicates that the Dual Antenna Arbitrator is in Automatic Mode.

Power - When illuminated, this LED indicates that Power is ON.

2.3. Automatic Mode

The normal mode of operation is Automatic. In automatic mode operator intervention is not required because the Dual Antenna Arbitrator will switch the antennas using the inputs from the two ACU’s. Press Auto to select this mode.

The latching logic is:

Antenna “A”	Antenna “B”	Action
Available	Not Available	Switch to ANT A
Available	Available	Do Not change state
Not Available	Available	Switch to ANT B
Not Available	Not Available	Do Not change state

Available - The antenna is tracking the desired satellite and the satellite modem has network lock. Satellite services are available from this antenna.

Not Available - The ACU will output "Blocked" and "Mute" signals to the Dual Antenna Arbitrator, indicating that that Satellite services are NOT available from this antenna if:

- The antenna is searching, targeting or is mispointed by more than 0.5 degrees.
- The antenna is within any one of the blockage zones saved in its ACU.
- Loss of Modem Lock will cause Search, leading to the same ACU output.
- Modem failure
- Failure in the RF Receive path to the modem.
- If Tracking is turned OFF and the AGC level of the ACU is below Threshold.
- This Antenna, or its ACU, is de-energized.

2.4. Manual Mode

Manual mode allows you to manually select which antenna is providing services to the modem. Manual mode will allow you to select an antenna, that would not be available in automatic mode, to provide services to the modem. While in manual mode of operation, operator action is REQUIRED to switch the antennas whenever necessary.

Press the **Manual** button to select Manual Mode of operation.

Then;

Press **ANT A** to select Antenna "A" to be the "Active" antenna.

Press **ANT B** to select Antenna "B" to be the "Active" antenna.

Press **Auto** to return to Automatic Mode of operation .

3. Remote Operation

Below are commands that are most commonly used for communicating with the ACU(s) or the Dual Antenna Arbitrator.

3.1. Automatic Beam Switching (ABS)

Listed below are the basic commands and their responses:

Name	Command	Response
Azimuth	Aaaaa [⚡]	
Elevation	Eaaaa [⚡]	
Satellite longitude	Tnnnn [⚡]	
Target NID	tnnnn [⚡]	
Tuning freq (MHz) or DVB/RF mode	cnnnn [⚡]	Lnnnn RL
Set Baud rate/KHz tuning	dnnnn [⚡]	Lnnnn RL
Target current Satellite (Find)	F [⚡]	
Polang Tx Type	mAnnn [⚡] A=087	m0nnn [⚡]
Satellite	mAnnn [⚡] A=104; A=105	m0nnn [⚡]
Satellite E/W	mAnnn [⚡] A=106;	m0nnn [⚡]
FEC Tone Volt	mAnnn [⚡] A=117	m0nnn [⚡]
Saved (Target) NID	mAnnn [⚡] A=125; A=126	m0nnn [⚡]
SatSkew	mAnnn [⚡] A=0138	m0nnn [⚡]
Status	S	S@@@Lnnnn RL \r\n
Relative AZ / Ships Heading	H	RrrrHaaaa \r\n
Az/EI/CI Position Decimal	P	EaaaaAaaaaCaaaa \r\n
Az/EI/CI Position Hex	p	ExxxxAxxxxCxxxx \r\n
Read Tuning Frequencies, Rec NID	q	Qnnnn nnnn xxxx \r\n

Notes:

- 1) Target NID is set using tnnnn but never read using mA commands.
- 2) Target NIDs of 54 and 55 are used to switch AUX on/off, effectively toggling CoPol/XPoL in legacy mode.
- 3) Target NIDs of 48 and 49 are used to switch Reflector A or B in dual-Reflector pedestals in legacy mode.

3.2. Open Antenna-Modem Interface Protocol (OpenAMIP™) Specification:

3.2.1. Overview:

OpenAMIP™, an ASCII message based protocol invented and Trademarked by iDirect is a specification for the interchange of information between an antenna controller and a satellite modem. This protocol allows the satellite modem to command the ACU (via TCP port 2002) to seek a particular satellite as well as allowing exchange of information necessary to permit the modem to initiate and maintain communication via the antenna and the satellite. In general, OpenAMIP™ is not intended for any purpose except to permit a modem and the ACU to perform synchronized automatic beam switching. It is **NOT** a status logging system or a diagnostic system. In addition, OpenAMIP™ is intended for a typical installation whereby a specific satellite modem and Antenna system are properly configured to work together. The protocol does not make specific provisions for auto-discovery or parameter negotiation. It is still the responsibility of the installer to ensure that the parameters of both the satellite modem (proper option files) and the ACU/PCU (setup parameters) are actually compatible for the intended satellite(s).

3.2.2. Interface requirements:**3.2.2.1. Hardware**

Sea Tel Antenna Control Units Model DAC-2202 or DAC-2302.

Any Satellite modem manufacturer that is compatible with OpenAMIP™

CAT5 Patch cable

3.2.2.2. Software

Sea Tel model DAC-2202:

ACU software version 6.06 or greater

CommIF module software version 1.10f or greater

Sea Tel model DAC-2302:

ACU software version 7.06 or greater

CommIF module software version 1.10f or greater

3.3. Dual Antenna Arbitrator Command Summary

Use the following commands to communicate directly with the Dual Antenna Arbitrator:

COMMAND	FUNCTION
set system default	Set all Arbitrator parameters to default
set system network {gateway netmask ip} nnn.nnn.nnn.nnn	Set network address values
set system mode {manu auto}	Set Arbitrator switching mode
set system forward port nnnnn	Set TCP forwarding port between DACs and modem
set system {username password}	Change default username or password
set antenna {alb} ip nnn.nnn.nnn.nnn	Set DAC A/B IP address
set antenna {alb} active	Set which antenna is currently active
set hot_standby {on off}	Turn 10MHz Reference for hot standby on/off
set gps source obm	Set GPS source to OBM or none
set gps source antenna {alb active}	Set GPS source to either antenna a/b/whichever is active
show all	Show all system parameters
show system network {gateway netmask ip}	Show the current network gateway, netmask, or IP address
show system mode	Show whether the Arbitrator is in auto or manual mode
show system forward port	Show which TCP port links the DACs and modem
show system version	Show the current loaded Arbitrator software version
show antenna {alb} ip	Show the IP address of DAC A/B
show antenna source	Show which antenna is used in the current RF path
show hot_standby	Show whether the hot standby reference is on/off
show gps source	Show the current source of GPS data
upgrade system serial	Update the Arbitrator software via the serial port
help	Show possible command options
save	Save the current parameters settings
{quit exit}	End the Telnet session
logout	Return to the Telnet session login screen
reset	Reboot the Arbitrator via software reset

ABBREVIATIONS:

aaaa	ASCII number of degrees in tenths.
xxxx	ASCII hex I/O data 0000 – FFFF range
nnnnn	ASCII decimal number (0000 - 99999)
nnnn	ASCII decimal number (0000 - 9999)
nnn	ASCII decimal number (0 - 255)

sss	ASCII string of characters.
If (0x0A) or \n	Line Feed (New Line)
↵, cr (0x0D) or \r	Carriage Return (Enter)

3.3.1. Command Details

set system default

The set system default command changes all of the Arbitrator's configurable parameters to their default values specified in Appendix B.

Note: This command choice will be confirmed by user with a prompt with arguments of {yes / no}. yes will confirm setting system parameters to default values; no will confirm ignoring of set system default command.

set system network {gateway / netmask / ip} nnn.nnn.nnn.nnn

The set system network command changes the values for the Arbitrator IP address, netmask, and network gateway. Parameters:

- gateway: changes the Arbitrator network gateway to value specified
- netmask: changes the Arbitrator netmask to value specified
- ip: changes the Arbitrator ip address to value specified
- nnn.nnn.nnn.nnn: argument specified in standard dot-decimal notation

Note: these changes will not be implemented until after a hardware or software reset. Note: the Arbitrator only supports IPv4

set system mode {manual / auto}

The set system mode command changes the Arbitrator switching mode. Parameters:

- manual: the active antenna is user selectable and will not switch based on antenna state
- auto: the active antenna is not user selectable and will switch automatically based on antenna state

set system forward port nnnnn

The system forward port command changes the TCP port on which packets will be forwarded to and from the satellite modem to the DACs. Parameters:

- nnnnn: This is the decimal value of the port number between 0-65535 inclusive.

set system {username / password} ssssssss

The set system username/password command changes the default username/password. Parameters:

- username: change the default username
- password: change the default password
- sssssss: the new username string

Note: the username/password must be alphanumeric and no longer than 9 characters. Note: the user will be prompted to confirm the username/password selection. To confirm, retype the username/password as entered in the command above. Any other input will force the username/password change to be ignored.

set antenna {a / b} ip nnn.nnn.nnn.nnn

The set antenna A/B ip command changes the IP addresses that correspond to ANT A/B DACs, use. Parameters:

- a: the IP entered corresponds to ANT A's DAC
- b: the IP entered corresponds to ANT B's DAC
- nnn.nnn.nnn.nnn: IP address specified in standard dot-decimal notation

Note: the Arbitrator only supports IPv4

set antenna {a / b} active

The set antenna A/B active command changes which antenna is currently active. Parameters:

a: ANT A is active

b: ANT B is active

Note: this will temporarily override the current active antenna regardless of switching mode. If the Arbitrator is in auto mode and the system state is such that the antenna not selected should be active, the Arbitrator will switch back to that antenna almost immediately.

set hot_standby {on / off}

The set hot standby command turns the 10MHz reference on or off. Parameters:

on: 10MHz oscillator will be enabled

off: 10MHz oscillator will be disabled

Note: Regardless of whether or not the connector is accessible on the back panel, this command will still configure the reference oscillator. For customers without the 10MHz Reference connector, it is recommended the hot_standby be turned off.

set gps source obm

The set gps source obm command changes the GPS source to be either the Out of Band Manger connected to the Arbitrator or have the GPS taken from a source that is not either antenna's DAC.

set gps source antenna {a / b / active}

The set gps source antenna command changes the GPS source to be one of the antenna's DACs. Parameters:

a: always take the GPS data from ANT A DAC

b: always take the GPS data from ANT B DAC

active: GPS data source will switch automatically along with RF path

show all

The show all command displays all of the Arbitrator's current settings.

Note: the output of this command is structured such that it can be issued back into the Arbitrator to restore its previous state.

show system network {gateway | netmask | ip}

The show system network command displays the Arbitrator network settings. Parameters:

gateway: displays the network gateway address in dot-decimal notation

netmask: displays the netmask in dot-decimal notation

ip: displays the Arbitrator IP address in dot-decimal notation

show system mode

The show system mode command displays the current Arbitrator switching mode.

show system forward port

The show system forward port command displays the current TCP forwarding port between the modem and the DACs.

show system version

The show system version command displays the current Arbitrator software version.

show antenna {a / b} ip

The show antenna A/B ip command displays the current IP addresses set for the two DACs.

Parameters:

a: shows DAC A's IP address in dot-decimal format

b: shows DAC B's IP address in dot-decimal format

show antenna source

The show antenna source command displays the current active antenna.

show hot_standby

The show hot_standby command displays the current status of the 10MHz oscillator.

show gps source

The show gps source command displays the current source of GPS data.

upgrade system serial

The upgrade system serial command upgrades the software version using the serial downloader.

help

The help command provides the user with additional information about the command structure in relation to what has been entered at the command prompt by the user.

save

The save command stores the current Arbitrator parameters.

Note: upon hardware or software reset, the Arbitrator will load the parameters from the last save point or the default parameters if a save point has not yet been created.

{quit | exit}

The quit or exit commands closes the Telnet session.

Note: this command is not valid for the serial interface.

logout

The logout command returns the user to the login screen of the Telnet interface.

Note: this command is not valid for the serial interface.

Reset

The reset command forces the Arbitrator to perform a software reset.

Note: any unsaved parameter changes will be lost upon hardware or software reset.

3.3.2. General Notes

Unless otherwise noted, the cr (0x0D), lf (0x0A), ">" echo indicates that the Arbitrator has accepted a command and is ready to process the next command. Any additional commands will not be accepted until after the Arbitrator echoes cr (0x0D), lf, ">".

All commands are case independent such that commands can be entered as all capital letters, all lower case, or a random mix for a valid command.

All commands should be followed by cr (0x0D) in order to be received and processed. This was intentionally omitted above for ease of readability.

Additional characters added after a valid command are not ignored and will return a user error message. After a valid command, " " (0x27) can be used to add comments or other characters to be ignored by the Arbitrator.

This Page Intentionally Left Blank

4. Dual Antenna Installation

The antennas used with this Dual Antenna Arbitrator can be Series 09MK3, Series 12 or Series 9711IMA.

If not already installed, refer to your antenna installation manual to install the two Sea Tel antennas. After the installation of the antennas, the MXP Antenna Control Units and the cables has been completed, refer to the information below to install the Dual Antenna Arbitrator.

4.1. *Unpacking and Inspection*

Exercise caution when unpacking the equipment.

1. Unpack the carton.
2. Carefully inspect the arbitrator for evidence of shipping damage.
3. Inventory the contents using the Bill Of Materials provided in the carton.
4. Inspect everything to assure that all materials have been received and are in good condition.

4.2. *Install the Dual Antenna Arbitrator*

Install the Dual Antenna Arbitrator in a convenient location within your 19" equipment rack where it is in proximity of both ACU's, satellite modem and any other below decks equipment that it will be connected to.

4.3. *Shipboard Cable Installation*



CAUTION: Rough handling, tight bending, kinking, crushing and other careless handling of the cables and their connectors can cause severe damage.

Use caution in installing interconnecting cables. Avoid routing cables across sharp edges that will cut or chafe these cables. Don't lay these cables on other power or signal cables which may induce noise into them. Avoid sharp bends, kinking, and the use of excessive force.

If slide rails are being used, assure that the cables are dressed & routed properly, and are of sufficient length, to allow the equipment to be pulled out on it's slide rails.

4.4. *Connecting the Below Decks Equipment*

You may also elect to provide an Ethernet router / hub / switch and install interconnecting cables between other below decks equipment than are sited herein. These additional Ethernet cables are not provided, nor are they discussed below.

Connect the Dual Antenna Arbitrator to the other below decks equipment as shown in the Simplified Block Diagram and as described below.



Series 12
Ku-Band
VSAT
Antenna "A"



Series 12
Ku-Band
VSAT
Antenna "B"

Above Decks Below Decks

220 VAC Air
Conditioner
Input Power

110/220 VAC
Pedestal Input
Power

220 VAC Air
Conditioner
Input Power

110/220 VAC
Pedestal Input
Power

If Active - TX IF & 10MHz Reference from Satellite Modem via Arbitrator
If Standby - 10MHz Reference (optional) from Arbitrator

If Active - TX IF & 10MHz Reference from Satellite Modem via Arbitrator
If Standby - 10MHz Reference (optional) from Arbitrator

MXP RXIF output from Antenna "A" to Satellite Modem through Arbitrator

MXP RXIF output from Antenna "B" to Satellite Modem through Arbitrator

RJ-45 Serial Cable - GPS & TX Inhibit Output and Satellite Modem Lock Input from MXP "A"

RJ-45 Serial Cable - GPS & TX Inhibit Output and Satellite Modem Lock Input from MXP "B"

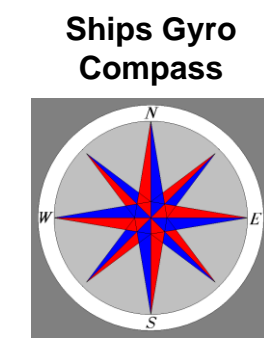
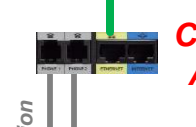
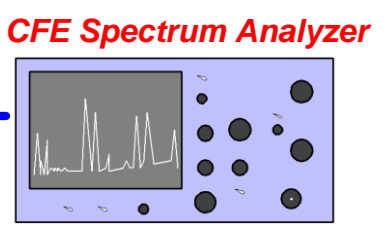
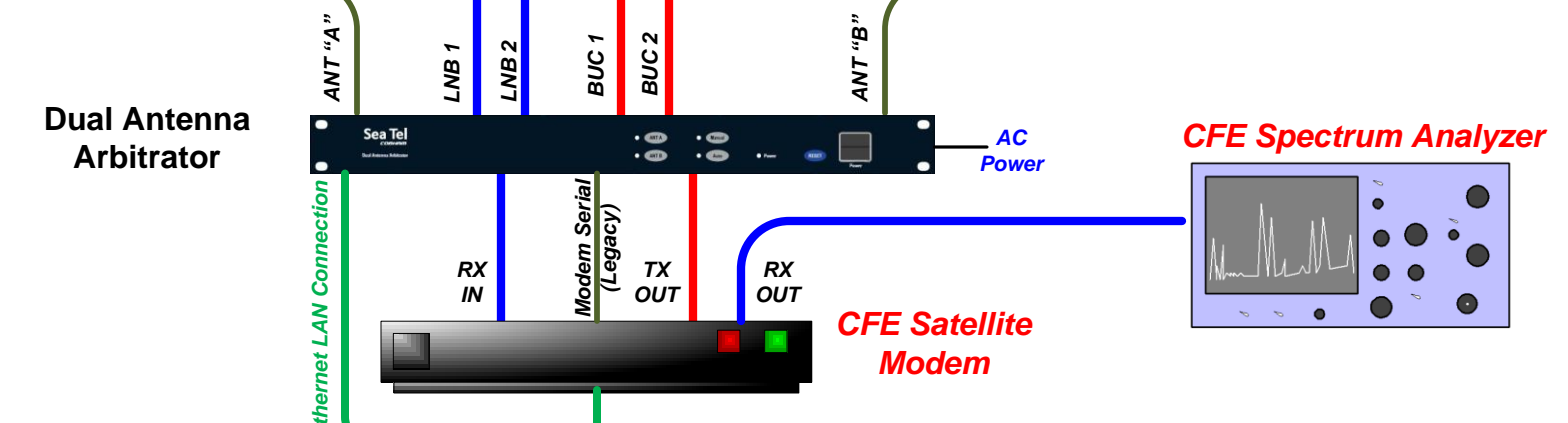
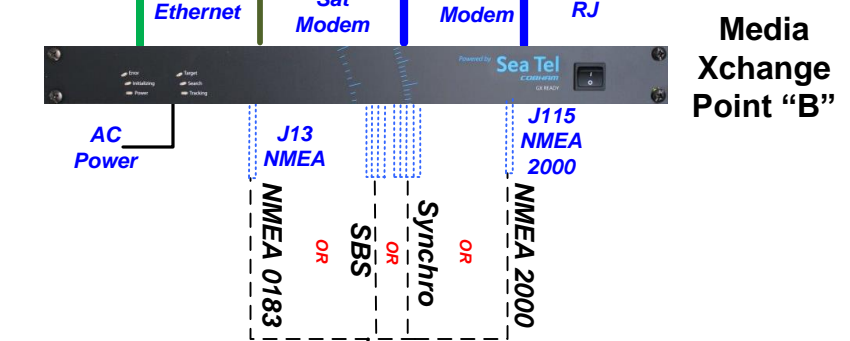
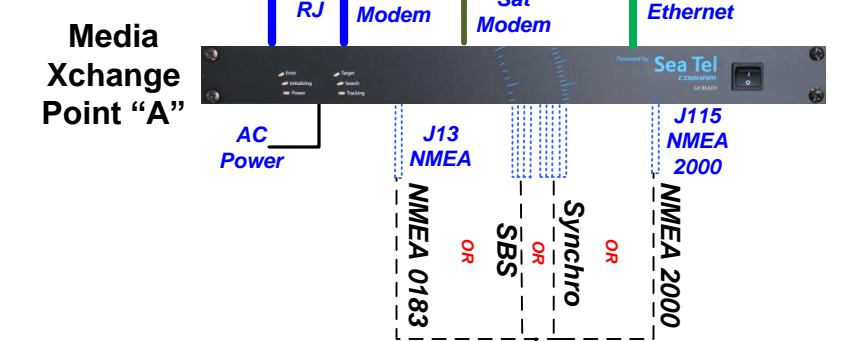

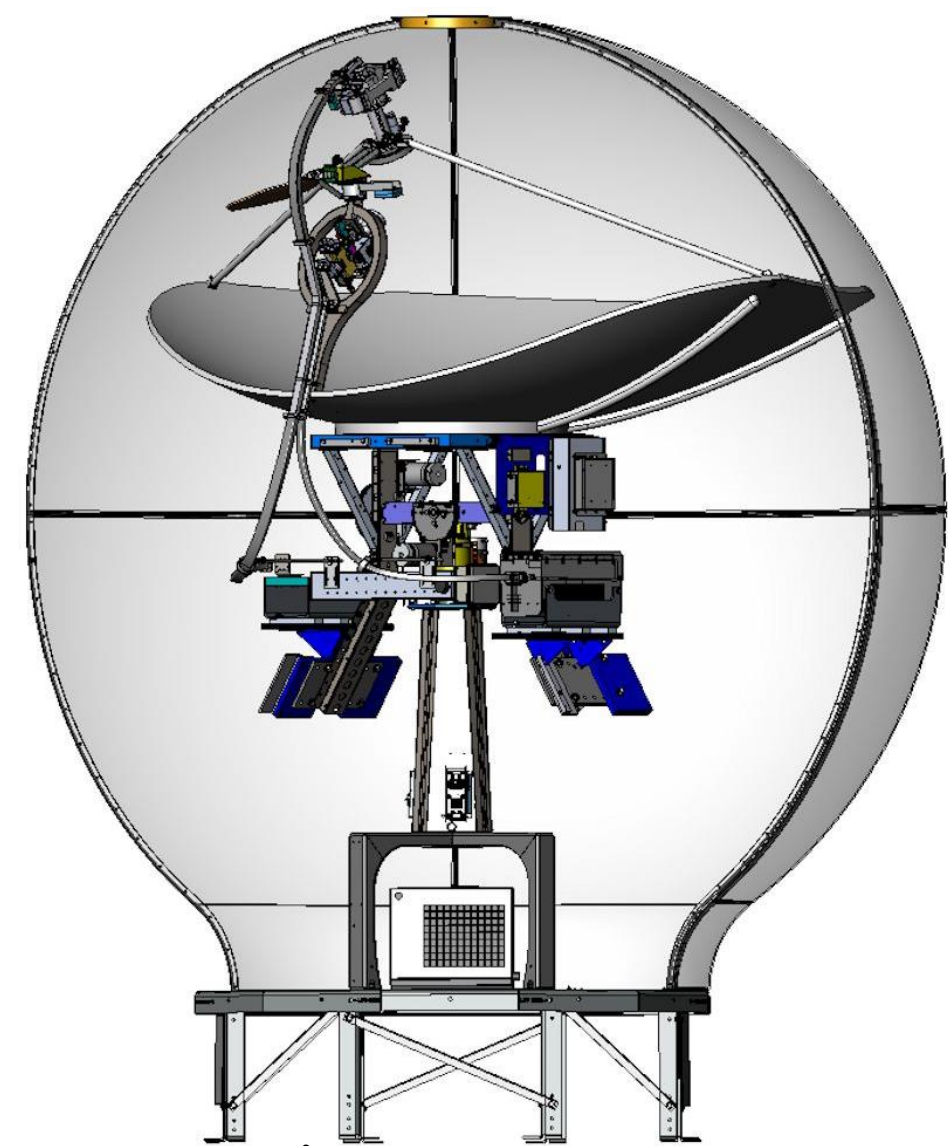

9711IMA
C & Ku-Band
VSAT
Antenna "A"

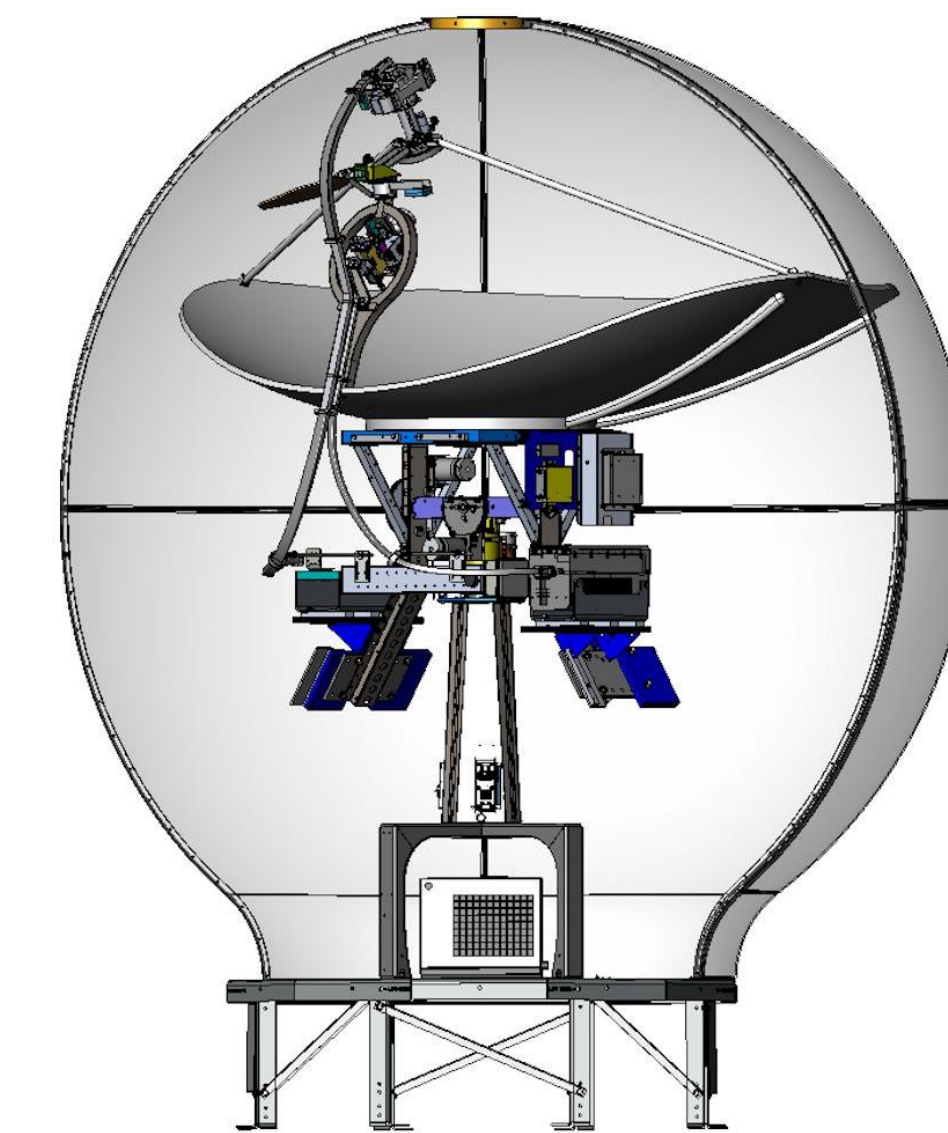

9711IMA
C & Ku-Band
VSAT
Antenna "B"

Above Decks Below Decks

220 VAC Air
Conditioner
Input Power

110/220 VAC
Pedestal Input
Power

220 VAC Air
Conditioner
Input Power

110/220 VAC
Pedestal Input
Power

If Active - TX IF & 10MHz Reference from Satellite Modem via Arbitrator
If Standby - 10MHz Reference (optional) from Arbitrator

If Active - TX IF & 10MHz Reference from Satellite Modem via Arbitrator
If Standby - 10MHz Reference (optional) from Arbitrator

MXP RXIF output from Antenna "A" to Satellite Modem through Arbitrator

MXP RXIF output from Antenna "B" to Satellite Modem through Arbitrator

RJ-45 Serial Cable - GPS & TX Inhibit Output and Satellite Modem Lock Input from MXP "A"

RJ-45 Serial Cable - GPS & TX Inhibit Output and Satellite Modem Lock Input from MXP "B"

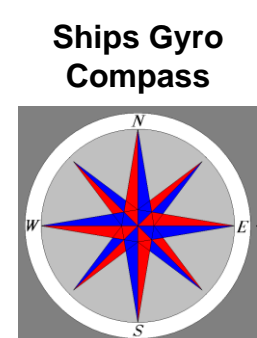
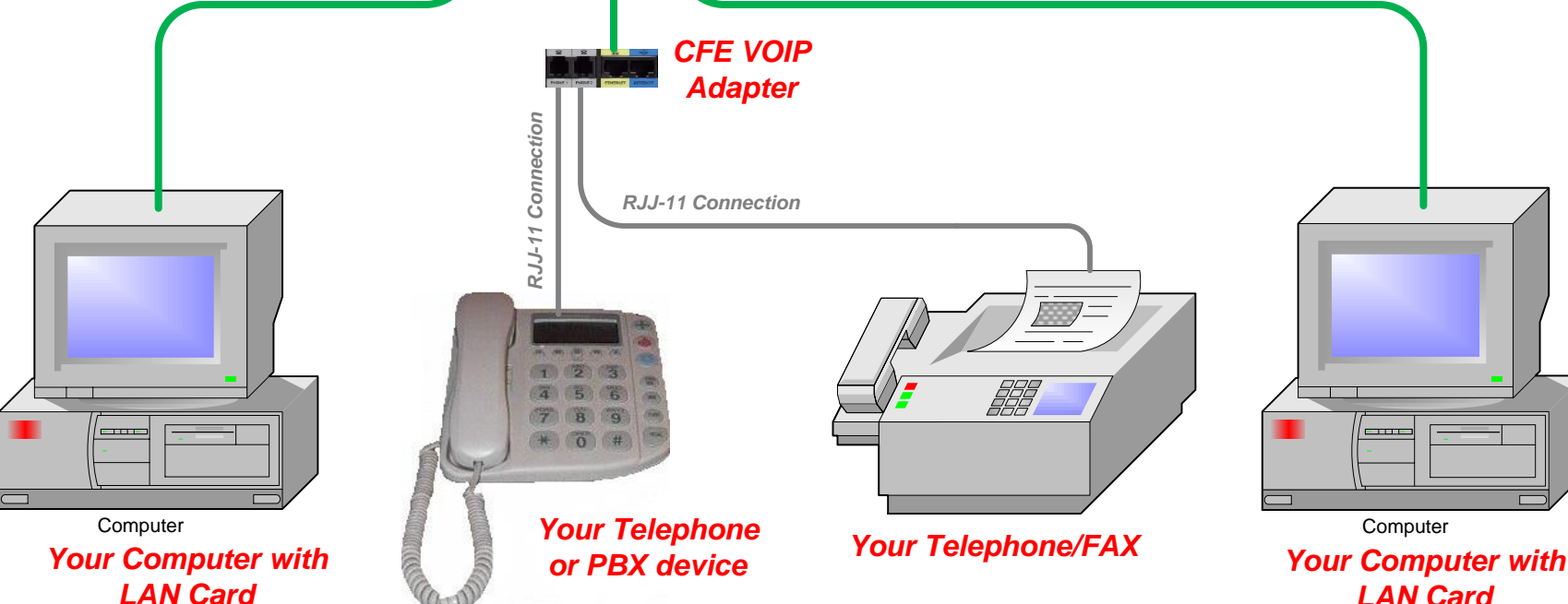
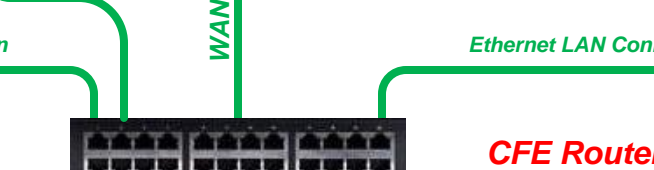
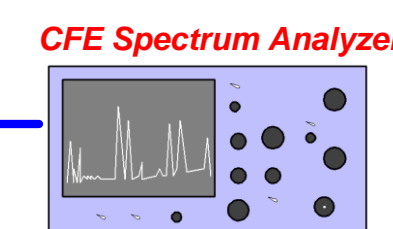
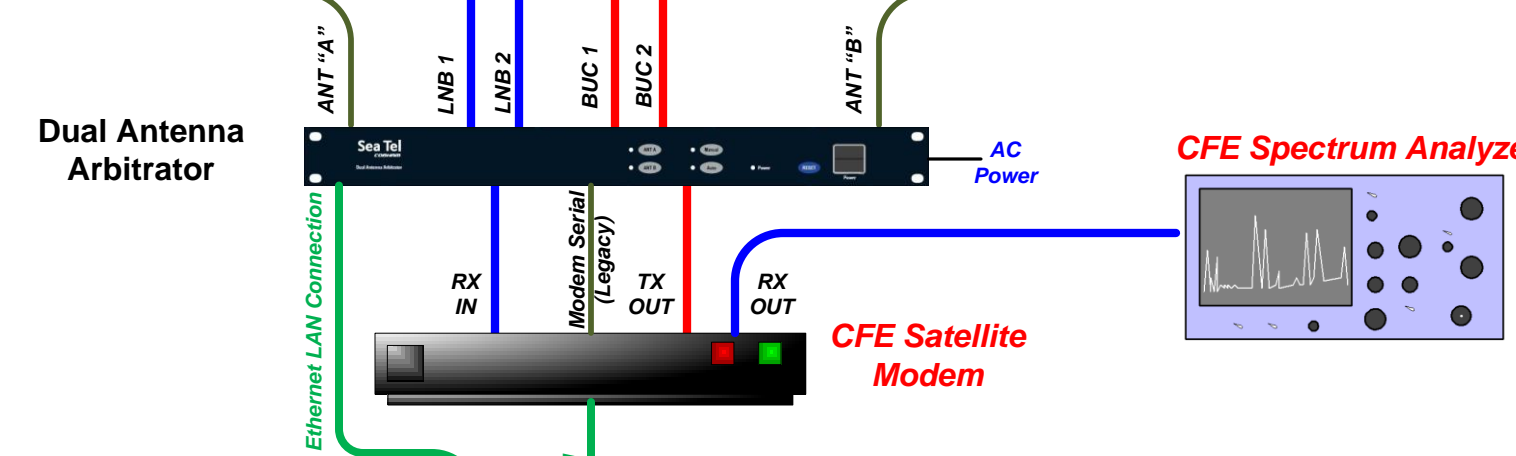
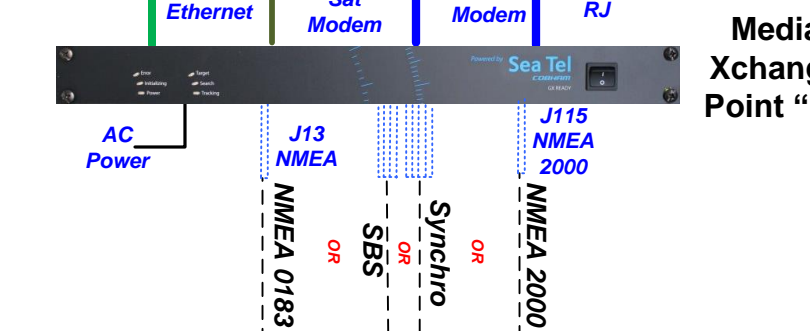
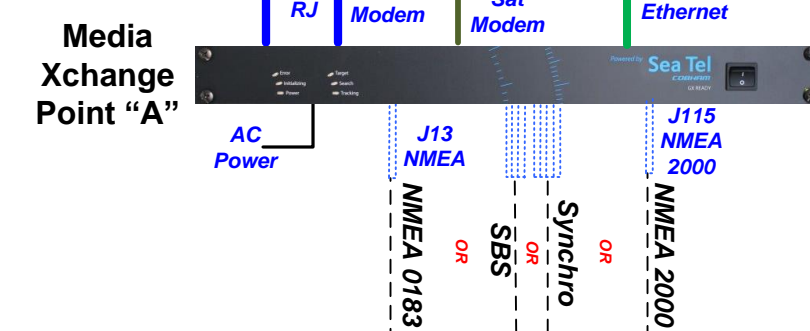

4.5. Dual Antenna Arbitrator Connections



AC Power Cable - Connect the AC Power cable from the rear of the Dual Antenna Arbitrator to an AC outlet fed from a suitably rated breaker or UPS.

LNB A - Connect an SMA-SMA coax cable assembly (Sea Tel PN 114972-1 or equivalent) with an SMA-F adapter (Sea Tel PN 115492-32 or equivalent) from here to J1 MODEM connector on the rear panel of MXP "A".

RX - Connect an SMA-SMA coax cable assembly (Sea Tel PN 114972-1 or equivalent) with an SMA-F adapter (Sea Tel PN 115492-32 or equivalent) from here to RF INPUT on your Satellite Modem.

LNB B - Connect an SMA-SMA coax cable assembly (Sea Tel PN 114972-1 or equivalent) with an SMA-F adapter (Sea Tel PN 115492-32 or equivalent) from here to J1 MODEM connector on the rear panel of MXP "B".

BUC A - Connect an SMA-N coax cable assembly (Sea Tel PN 111079-6 or equivalent) from here to the TX connector on ADE/BDE coax cable interconnect bracket "A".

10MHz Out - Connect an SMA-SMA coax cable jumper assembly (Sea Tel PN 114972-1 or equivalent) with an from here to **10MHz IN** on the arbitrator.

TX - Connect an SMA-SMA coax cable assembly (Sea Tel PN 114972-1 or equivalent) with an SMA-F adapter (Sea Tel PN 115492-32 or equivalent) from here to TX OUTPUT on your Satellite Modem.

BUC B - Connect an SMA-N coax cable assembly (Sea Tel PN 111079-6 or equivalent) from here to the TX connector on ADE/BDE coax cable interconnect bracket "B".

DAC "A" TMS - Connect an RJ-45 serial cable from here to J10C MODEM on MXP "A".

DAC "B" TMS - Connect an RJ-45 serial cable from here to J10C MODEM on MXP "B".

MODEM -

Legacy Configurations: - If you have a legacy configuration with hardwire serial connection for TX Mute, Satellite Modem Network Lock and GPS.

- **iDirect Modem** - Connect RJ-45 Serial cable from the **Modem** connector on the rear panel of the arbitrator **Console** connector on the rear panel of the satellite modem.
- **ComTech Modem** - Connect the ComTech cable assembly (135192) from the **Modem** connector on the rear panel of the arbitrator to the **Alarm** connector on the rear panel of the satellite modem.

Ethernet Configurations: If your satellite modem is capable of communicating TX Mute, Satellite Modem Network Lock and GPS with the MXPs via Ethernet:

- Do NOT connect this Modem port to anything. See Ethernet connection below.
- Connect each MXP Ethernet connector J3A to an open port on your Ethernet router/hub/switch using an Ethernet patch cable (Sea Tel PN 119479-10 or equivalent).

OBM - Not used in this configuration.

ETHERNET - Connect an Ethernet patch cable (Sea Tel PN 119479-10 or equivalent) from here to an open port on your Ethernet router/hub/switch.

CONSOLE - Not used in this configuration.

4.6. MXP Connections

This connection will have been made during the installation of the antennas. Assure that they are correct, changing or adding connections as necessary.

RX L-Band A - Connect an N-SMA coax cable assembly from the antenna "A" ADE/BDE coax cable interconnect bracket to J2 RJ connector on the rear panel of MXP "A".

RX L-Band B - Connect an N-SMA coax cable assembly from the antenna "B" ADE/BDE coax cable interconnect bracket to J2 RJ connector on the rear panel of MXP "B".

CFE Computer ETHERNET - Connect an Ethernet patch cable (Sea Tel PN 119479-10 or equivalent) from your local computer to an open port on your Ethernet router/hub/switch.

MXP A ETHERNET - Connect an Ethernet patch cable (Sea Tel PN 119479-10 or equivalent) from J3A on the rear panel of MXP "A" to an open port on your Ethernet router/hub/switch.

MXP B ETHERNET - Connect an Ethernet patch cable (Sea Tel PN 119479-10 or equivalent) from J3A on the rear panel of MXP "B" to an open port on your Ethernet router/hub/switch.

Modem ETHERNET - Connect an Ethernet patch cable (Sea Tel PN 119479-10 or equivalent) from your satellite modem to an open port on your Ethernet router/hub/switch.

4.7. **Set-up**

Both antennas must be set-up & RF balanced to optimize their performance on the same satellite.

4.7.1. **IP Address Setting**

4.7.1.1. **MXP "A"**

1. Log into MXP "A" and access the access the Network Configuration section of the Communication Interfaces page.
2. Set the IP address of MXP "A" (and other settings as necessary) to be appropriate for your network.
3. Save the setting changes.

4.7.1.2. **MXP "B"**

1. Log into MXP "B" and access the access the Network Configuration section of the Communication Interfaces page.
2. Set the IP address of MXP "B" to be the value of (MXP "A" PLUS 1 – if MXP "A" was set to 10.1.1.100, then MXP "B" will be set to 10.1.1.101). Set any other settings, that were changed in MXP "A", as necessary and appropriate for your network.
3. Save the setting changes.

4.7.1.3. **Arbitrator**

1. Log into the Arbitrator and access the access the network configuration section to enter the IP Addresses (and any other settings that also need to be changed) of MXP "A" and MXP "B".
2. Save the setting changes.

4.7.2. **MXP Tracking Settings**

Refer to the antenna installation manual to optimize the tracking settings for the desired satellite(s).

4.7.3. **MXP Targeting**

Refer to the antenna installation manual to optimize the targeting of the antenna on the desired satellite.

4.7.4. **MXP Blockage Zones**

Refer to the antenna installation manual to enter blockage zones of mast, stack or other structures aboard the ship which block the satellite signal from reaching each of the two Sea Tel antennas.

4.7.5. **Balancing TX Output**

To provide seamless switching performance on the satellite network, it may be necessary to balance the RF performance (TX & RX) of the two antennas to compensate for dissimilar antenna sizes, BUC & LNB gains, different cable losses, etc.

NOTE: You will cause other users to be knocked off of the network if you switch to an antenna which has more than 2 dB difference, and may cause detrimental impact on the network if the difference is greater than 4 dB.

Refer to the Setup chapter in this manual to balance the outputs of your antennas.

4.8. **Testing Arbitrator Switching**

Refer to the Functional Testing chapter of this manual to test the switching of this Dual Antenna Arbitrator.

This Page Intentionally Left Blank

5. Setup

5.1. Default Parameter Settings:

The default settings in the Dual Antenna Arbitrator and in the two Antenna Control Units typically are as listed in the table below. You may need, or elect, to change these to conform with your network or LAN.

	ARBITRATOR	MXP A	MXP B
User Name	seatel		
Password	1234		
IP Address	192.168.30.194	10.1.1.100	10.1.1.101
Subnet mask	255.255.255.0	255.255.255.0	255.255.255.0
Default Gateway	192.168.30.254	10.1.1.105	10.1.1.105
UDP Port	3000	3000	3000
Forward Port	2002		
Management ports		2000 : 2001	2000 : 2001
Serial Baud Rate	9600		
Telnet Port	23		
Arbitrator Switching Mode	Auto		
Default Active Antenna	ANT A		
Arbitrator GPS Source	Active DAC		
10MHz Hot Standby	Off		
Default Mute Polarity	Low Voltage		

5.2. Balancing TX Output

To provide seamless switching performance on the satellite network, it may be necessary to balance the RF performance (TX & RX) of the two antennas to compensate for dissimilar antenna sizes, BUC & LNB gains, different cable losses, etc.

NOTE: You will cause other users to be knocked off of the network if you switch to an antenna which has more than 2 dB difference and may cause detrimental impact on the network if the difference is greater than 4 dB.

1. Contact NOC technician
2. Select Manual Mode
3. Select ANT A
4. Conduct cross-pol isolation optimization with the NOC technician.
5. Conduct 1dB compression test on Antenna "A", measure using one of the following means:
 - Feedback from the network (preferred).
 - Radio M&C power output value, if available on your RF equipment.
 - Power meter
 Record TX Output @ 1dB compression point. ____ dB
6. Measure RX signal level at the RX Input to the satellite modem using a spectrum analyzer, modem signal level, EbNo or SNR value. Record RX Input ____ dB
7. Select ANT B
8. Conduct cross-pol isolation optimization with the NOC technician.
9. Conduct 1dB compression test on Antenna "B", measure using one of the following means:
 - Feedback from the network (preferred).
 - Radio M&C power output value, if available on your RF equipment.

- Power meter

Record TX Output @ 1dB compression point. ____ dB

10. Measure RX signal level at the RX Input to the satellite modem using a spectrum analyzer, modem signal level, EbNo or SNR value. Record RX Input ____ dB
11. Compare measured RX output levels and notify operators if the difference is greater than +/-1.0 dB of each other ... this is for informational purposes only, so that the operators know differences in performance when switching. RX in-line attenuators may be installed at the LNB input to the Dual Antenna Arbitrator which has the higher RX signal level, if balanced performance is desired, but it is not necessary.
12. Compare measured TX results to determine if the outputs are balanced. Outputs **must not be** greater than +/-2.0 dB **MAX** of each other. If necessary, add TX attenuation via BUC M&C, or by installing in-line attenuators (not supplied) at the input, of the BUC which has the higher power output to balance the performance of the two antennas within +/- 1.0 dB.
13. Verify with the NOC that the TX outputs (RX signal level at the network) from ANT A & ANT B are equal +/- 1.0dB.
14. Select Auto Mode.

6. Functional Testing

Test the Dual Antenna Arbitrator to assure it switches properly when one, or the other, antenna is blocked and that you are getting proper modem lock to both Antenna Control Units.

6.1. *Test Dual Antenna Arbitrator - Manual Mode*

Manual mode allows you to manually select which antenna is providing services to the modem. Manual mode will allow you to select an antenna, that would not be available in automatic mode, to provide services to the modem. While in manual mode of operation, operator action is REQUIRED to switch the antennas whenever necessary.

1. Observe the front panel LEDs to ascertain which antenna is currently the "Active" antenna (default on power-up is Antenna "A"). This procedure assumes that Antenna "A" is currently that "Active" antenna.
2. Press the **Manual** button to select Manual Mode of operation.
3. Press **ANT B** to select Antenna "B" to be the "Active" antenna.
4. Verify that Antenna "B" LED is lit and that services have switched to antenna "B".
5. Verify that satellite modem lock is achieved.
6. Verify that network voice/data services are functioning normally.
7. Press **ANT A** to select Antenna "A" to be the "Active" antenna.
8. Verify that Antenna "A" LED is lit and that services have switched to antenna "A".
9. Verify that satellite modem lock is achieved.
10. Verify that network voice/data services are functioning normally.
11. Press **Auto** to return to Automatic Mode of operation .

This Page Intentionally Left Blank

7. Troubleshooting & Maintenance

7.1. *Isolating IF & RF problems:*

Refer to the appropriate Simplified Block Diagram for your system to trace the TX IF or RX IF signal paths between the ADE and BDE. Use a spectrum analyzer to test IF and RF signals.

- For ADE RF problems refer to the System Block Diagram in your antenna manual.
- For BDE RF problems refer to the appropriate Simplified Block Diagram in this manual. (Note: When the Dual Antenna Arbitrator loses power the switches will default to ANT A).

7.2. *GPS problems:*

Hardwire (DAA Modem to Modem Console Port) configuration:

- Check to assure GPS is updating each MXP with the correct position information.
- Check continuity of each of the interconnecting RJ-45 console cables between the MXPs and the Dual Antenna Arbitrator.
- Check GPS setting in the Dual Antenna Arbitrator.
- Check continuity of the interconnecting RJ-45 console cable, or Ethernet cable, between the Dual Antenna Arbitrator and the Satellite Modem.
- Query the GPS LAT/LON position in the PCU, ACU and in the modem.

OpenAMIP Ethernet Configuration:

- Check to assure GPS is updating each MXP with the correct position information.
- Check continuity of each of the interconnecting RJ-45 console cables between the MXPs and the Dual Antenna Arbitrator.
- Check GPS setting in the Dual Antenna Arbitrator.
- Check continuity of the interconnecting RJ-45 Ethernet cable, between the Dual Antenna Arbitrator and the Satellite Modem.
- Query the GPS LAT/LON position in the PCU, ACU and in the modem.

7.3. *Network Lock problems:*

If Network lock is not getting into the MXPs, you will have to ascertain if the problem is in the modem, the Dual Antenna Arbitrator or any one of the other interconnecting cables which carry this signal.

If your modem does NOT have network lock output available:

- Assure that the Modem settings in you MXP are set to reflect that, so that the system will track on any satellite signal level, at the tracking frequency, which is above threshold.

If your modem does have network lock output available:

- Test the output from the modem to the Dual Antenna Arbitrator.
- Check continuity of the interconnecting RJ-45 serial cables between the MXPs and the Dual Antenna Arbitrator. If your system is Ethernet based, check continuity of the Ethernet cable(s) to the MXPs.
- Check continuity of the interconnecting RJ-45 console cable, or Ethernet cable, between the Dual Antenna Arbitrator and the Satellite Modem.
- Test the Satellite Modem Lock input to **EACH** MXP.

7.4. ***TX Mute problems:***

If your modem does NOT have a “TX Mute” input available - The system will NOT be able to comply with US FCC requirements.

If your modem does have a “TX Mute” input available:

- Test the TX Mute output from ***EACH*** MXP into satellite modem to assure that the input mutes transmit in the modem.
- Check continuity of the interconnecting RJ-45 console cable, or Ethernet cable, between the Dual Antenna Arbitrator and the Satellite Modem.
- Check continuity each of the interconnecting RJ-45 cables between the MXPs and the Dual Antenna Arbitrator.
- Query the TX Mute (TX enable = OFF, or TX disable = ON) status in the modem.

8. Slide Rail Kit (optional) Installation

If you have purchased the optional slide rail kit, follow the instructions below to install the slide rails. Refer to drawing 135681 in the drawing section of this manual.

8.1. *Assembling the Outer Rails*

Refer to drawing 135681 Detail A to assemble the outer rails for the inside of the rack.

1. Attach the Mounting brackets to the rack rails using the hardware provided. Do not tighten the hardware at this time.
2. Adjust the mounting brackets to the correct length for the rack that they will be installed in (test fit in the rack is highly recommended).
3. Apply Loctite 242 to and tighten the mounting bracket hardware.

8.2. *Mounting the Outer Rails In the Rack*

Refer to drawing 135681 Detail C to install the outer rails into your equipment rack. Refer to detail C1, C2 or C3 as is appropriate for the vertical rails in your equipment rack.

1. Attach the Mounting brackets to the vertical rack rails using the appropriate hardware (provided per detail C1, C2 or C3 as is appropriate for the type of vertical rails in your equipment rack).
2. Tighten the mounting bracket hardware.

8.3. *Mounting the Inner Rails*

Refer to drawing 135681 Detail B to assemble the outer rails for the inside of the rack.

1. Attach the inner rails to the body of the Arbitrator using the hardware provided.
2. Apply Loctite 242 to and tighten the mounting hardware.

8.4. *Mounting the Arbitrator Into Your Rack*

Refer to drawing 135681 Detail D to install the Arbitrator into your equipment rack.

1. Slide the inner rails mounted to the Arbitrator into the outer rails mounted in the equipment rack.
2. Route and connect the cables to the rear of the Arbitrator, assuring that you have sufficient cable length to allow the Arbitrator to be fully extended out on its slides without chaffing or tearing the cables.
3. Push the Arbitrator fully into the rack.
4. Install the 4 retaining screws through the front panel of the Arbitrator into the vertical rails and tighten.

This Page Intentionally Left Blank

9. Specifications

The technical specifications for the Dual Antenna Arbitrator are:

9.1. General

Physical Dimensions:	Rackmount: 4.5 x 43.2 x 25.4 cm (1.75 x 17 x 10 inches)
Input Voltage:	88-264 VAC, 47-63 Hz, 1 phase
Power Requirements:	160 Watts maximum
Weight	2.8 kg (6.2 lbs)

9.2. Front Panel

Status Indicator Display:	4 LED enunciators for Ant A, Ant B, Manual and Auto
Ant A Button	Select Ant A as Active Antenna (Manual Mode Only)
Ant B Button	Select Ant B as Active Antenna (Manual Mode Only)
Manual Button	Manual Mode
Auto Button	Automatic Mode
Reset Button	Resets the Arbitrator
Controls:	AC Power On/Off

9.3. Rear Panel

The connectors available on the rear panel are:

9.3.1. AC POWER

Connection IEC receptacle with line filter.

9.3.2. Switch Plate - Standard Low Power

The standard switch plate, mounted in the rear panel, has the following connections:

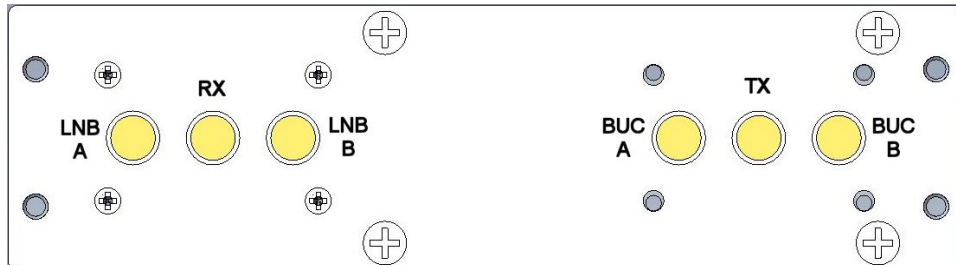

9.3.2.1. LNB A - RX IF Input from Antenna A

SMA-Type, 50 Ohm, coax switch	
Frequency Pass	DC – 4.0 GHz:
Insertion Loss:	0.1dB Typical
Isolation:	80dB
Switching Time:	15 ms max

9.3.2.2. RX - RX IF Output to Modem

SMA-Type, 50 Ohm, coax switch	
Frequency Pass	DC – 4.0 GHz:
Insertion Loss:	0.1dB Typical
Isolation:	80dB
Switching Time:	15 ms max

9.3.2.3. LNB B - RX IF Input from Antenna B

SMA-Type, 50 Ohm, coax switch

Frequency Pass	DC – 4.0 GHz:
Insertion Loss:	0.1dB Typical
Isolation:	80dB
Switching Time:	15 ms max

9.3.2.4. **BUC A - TX IF Output to Antenna A BUC**

SMA-Type, 50 Ohm, coax switch

Frequency Pass	DC – 4.0 GHz:
Insertion Loss:	0.1dB Typical
Isolation:	80dB
Switching Time:	15 ms max

9.3.2.5. **TX - TX IF Input from Modem**

SMA-Type, 50 Ohm, coax switch

Frequency Pass	DC – 4.0 GHz:
Insertion Loss:	0.1dB Typical
Isolation:	80dB
Switching Time:	15 ms max

9.3.2.6. **BUC B - TX IF Output to Antenna B BUC**

SMA-Type, 50 Ohm, coax switch

Frequency Pass	DC – 4.0 GHz:
Insertion Loss:	0.1dB Typical
Isolation:	80dB
Switching Time:	15 ms max

9.3.3. **Switch Plate - 10 MHz Option**

The 10MHz Option switch plate, mounted in the rear panel, has the following connections:

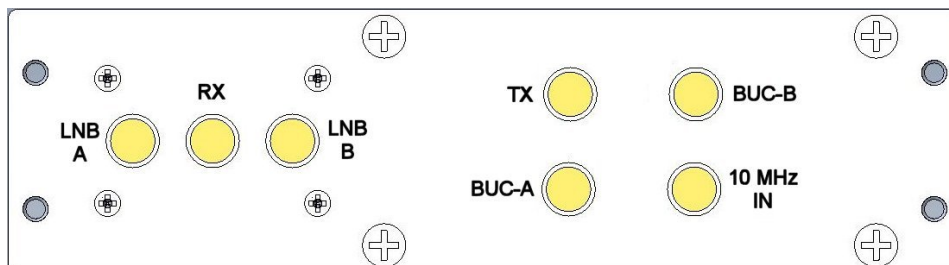

9.3.3.1. **LNB A - RX IF Input from Antenna A**

SMA-Type, 50 Ohm, coax switch

Frequency Pass	DC – 4.0 GHz:
Insertion Loss:	0.1dB Typical
Isolation:	80dB
Switching Time:	15 ms max

9.3.3.2. **RX - RX IF Output to Modem**

SMA-Type, 50 Ohm, coax switch

Frequency Pass	DC – 4.0 GHz:
Insertion Loss:	0.1dB Typical
Isolation:	80dB
Switching Time:	15 ms max

9.3.3.3. **LNB B - RX IF Input from Antenna B**

SMA-Type, 50 Ohm, coax switch

Frequency Pass	DC – 4.0 GHz:
Insertion Loss:	0.1dB Typical
Isolation:	80dB

Switching Time: 15 ms max

9.3.3.4. BUC A - TX IF Output to Antenna A BUC

SMA-Type, 50 Ohm, coax switch

Frequency Pass DC – 4.0 GHz:
 Insertion Loss: 0.2dB Typical
 Isolation: 80dB
 Switching Time: 15 ms max

9.3.3.5. TX - TX IF Input from Modem

SMA-Type, 50 Ohm, coax switch

Frequency Pass DC – 4.0 GHz:
 Insertion Loss: 0.2dB Typical
 Isolation: 80dB
 Switching Time: 15 ms max

9.3.3.6. BUC B - TX IF Output to Antenna B BUC

SMA-Type, 50 Ohm, coax switch

Frequency Pass DC – 4.0 GHz:
 Insertion Loss: 0.2dB Typical
 Isolation: 80dB
 Switching Time: 15 ms max

9.3.4. Switch Plate - High Power Option

The 10MHz Option switch plate, mounted in the rear panel, has the following connections:

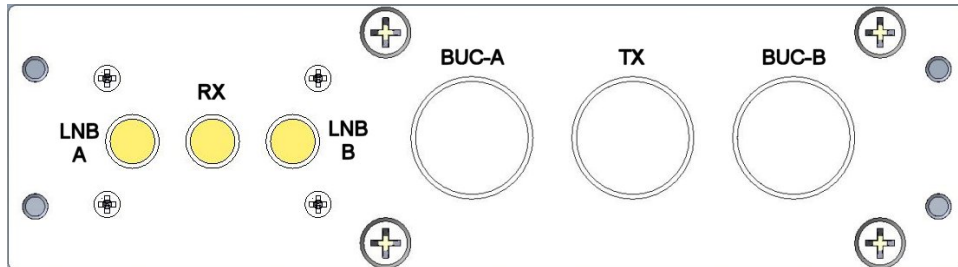

9.3.4.1. LNB A - RX IF Input from Antenna A

SMA-Type, 50 Ohm, coax switch

Frequency Pass DC – 4.0 GHz:
 Insertion Loss: 0.1dB Typical
 Isolation: 80dB
 Switching Time: 15 ms max

9.3.4.2. RX - RX IF Output to Modem

SMA-Type, 50 Ohm, coax switch

Frequency Pass DC – 4.0 GHz:
 Insertion Loss: 0.1dB Typical
 Isolation: 80dB
 Switching Time: 15 ms max

9.3.4.3. LNB B - RX IF Input from Antenna B

SMA-Type, 50 Ohm, coax switch

Frequency Pass DC – 4.0 GHz:
 Insertion Loss: 0.1dB Typical
 Isolation: 80dB
 Switching Time: 15 ms max

9.3.4.4. BUC A - TX IF Output to Antenna A BUC

SMA-Type, 50 Ohm, coax switch

Frequency Pass	DC – 4.0 GHz:
Insertion Loss:	0.2dB Typical
Isolation:	80dB
Switching Time:	15 ms max

9.3.4.5. TX - TX IF Input from Modem

SMA-Type, 50 Ohm, coax switch

Frequency Pass	DC – 4.0 GHz:
Insertion Loss:	0.2dB Typical
Isolation:	80dB
Switching Time:	15 ms max

9.3.4.6. BUC B - TX IF Output to Antenna B BUC

SMA-Type, 50 Ohm, coax switch

Frequency Pass	DC – 4.0 GHz:
Insertion Loss:	0.2dB Typical
Isolation:	80dB
Switching Time:	15 ms max

9.4. Compliance

CE / R&TTE testing:

EMC:	EN60945
Safety:	EN60950

RoHS Compliant

9.5. Environmental Conditions

The following requirements apply to equipment installed in weather protected locations.

Temperature	0 to 40 degrees C
Humidity	Up to 80% @ 40 degrees C, Non-condensing

10. Drawings

10.1. *Dual Antenna Arbitrator Drawings*

Drawing	Title	
133804-1	Dual Antenna Arbitrator Kit (MXP	10-3
135681-7_A	Rack Mount Slide Kit	10-4

This Page Intentionally Left Blank

SINGLE LEVEL MFG BILL OF MATERIAL

FIND	QTY	PART NO	REV	DESCRIPTION	REFERENCE DESIGNATOR
1	1 EA	133570-1	A	ENCLOSURE ASS'Y, ARBITRATOR	
2	4 EA	119478-5	D	CABLE ASS'Y, RJ-45 SERIAL, 60 IN.	
3	1 EA	119479-10	B1	CABLE ASS'Y, CAT5 JUMPER, 10 FT.	
4	4 EA	114972-1	N	CABLE ASS'Y, SMA(M) - SMA(M), 60 IN	
5	2 EA	111079-6	G1	CABLE ASS'Y, SMA(M)-N(M), 6 FT.	
6	4 EA	125580-3	A	IMPEDANCE MATCHING PAD, 50-75 OHM, SM	
7	1 EA	120643-25	B	CABLE ASS'Y, RS232, 9-WIRE, STRAIGHT,	
10	1 EA	135192-1	A	CABLE ASSEMBLY, RJ45 - BARE WIRE, 72	
11	1 EA	135512	X1	CUSTOMER DOC KIT, ARBITRATOR	

<h1>Sea Tel</h1> <p><i>COBHAM</i></p>				
KIT, ARBITRATOR TX/RX, STANDARD				
PROD FAMILY COMMON	EFF. DATE 9/13/2011	SHT 1 OF 1	DRAWING NUMBER 133804-1	REV A

SINGLE LEVEL ENGR BILL OF MATERIAL

FIND	QTY	PART NO	REV	DESCRIPTION	REFERENCE DESIGNATOR
1	2 EA	127545-7	A	EXTENSION SLIDE, CLB-203-22, 22 IN	
2	4 EA	135221-1	X1	MOUNTING BRACKET, RACK SLIDE	
50	2 EA	114588-825		SCREW, PAN HD, PHIL, 10-32 x 1/4, S.S.	
51	2 EA	114588-818		SCREW, PAN HD, PHIL, 10-32 x 7/16, S.S.	
52	10 EA	114588-830		SCREW, PAN HD, PHIL, 10-32 x 5/8, S.S.	
53	6 EA	135692-127	X1	CAGE NUT, SQUARE STYLE, 10-32, ZINC P	
54	6 EA	135693-343	X1	CAGE NUT, G-STYLE, 10-32, ZINC PLATED	
58	14 EA	114580-230		WASHER, FLAT, M4, S.S.	
59	2 EA	135691-1	X1	BAR NUT, RACK SLIDE MOUNTING, 10-32,	
60	4 EA	119745-222		SCREW, PAN HD, PHIL, M4 X 12, S.S.	
70	2 EA	119745-420		SCREW, PAN HD, PHIL, M6 x 10, S.S.	
71	10 EA	119745-426		SCREW, PAN HD, PHIL, M6 x 16, S.S.	
78	14 EA	114580-250		WASHER, FLAT, M6, S.S.	
79	1 EA	117319-4	E	LOCTITE PRODUCTS, 242 THREADLOCKE	

				
RACK MOUNT SLIDE KIT, 22 IN				
PROD FAMILY COMMON	EFF. DATE 16-Nov-11	SHT 1 OF 1	DRAWING NUMBER 135681-7	REV A

REVISION HISTORY				
REV	ECO#	DATE	DESCRIPTION	BY

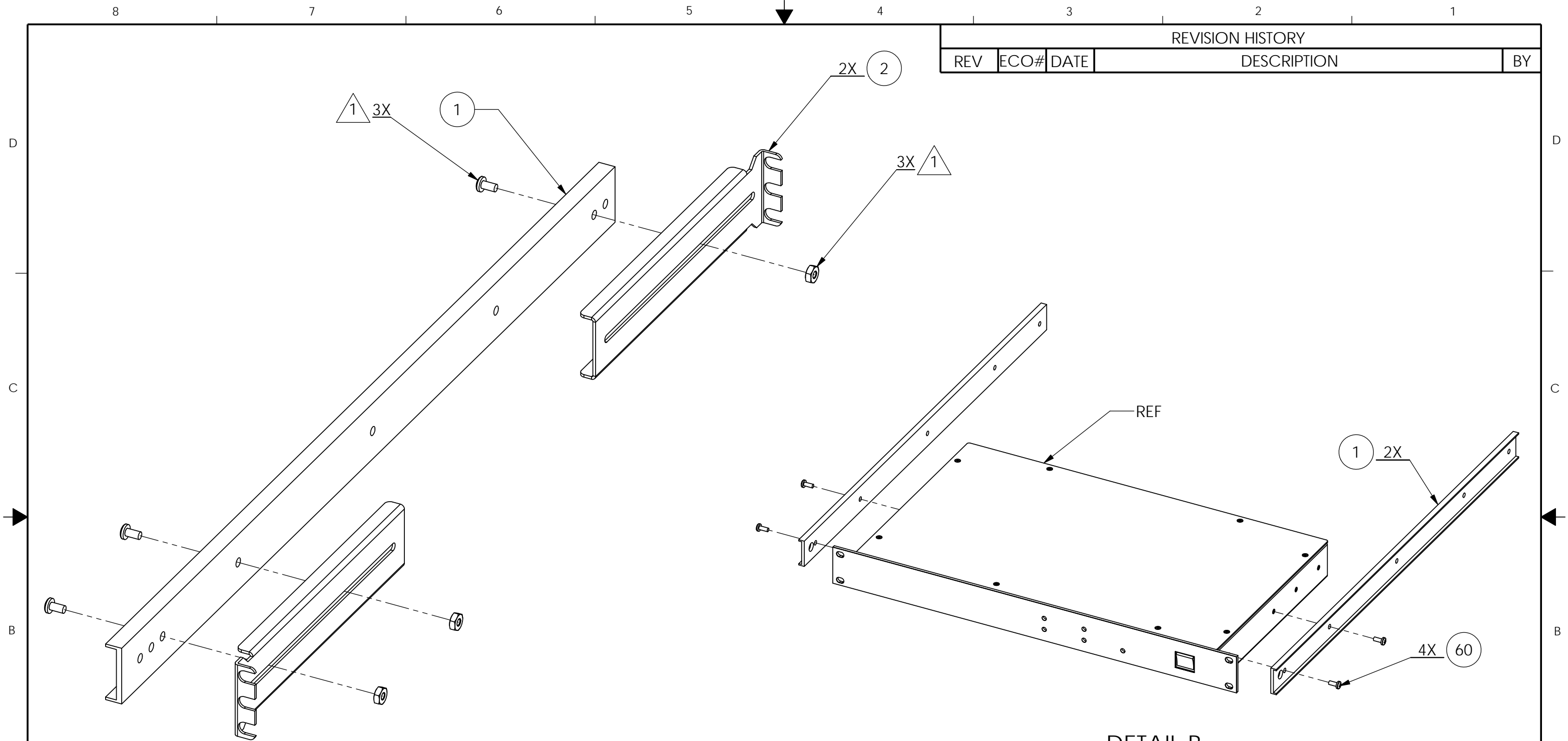

DETAIL A

DETAIL B

NOTES: UNLESS OTHERWISE SPECIFIED
 1 (triangle) HARDWARE INCLUDED IN 124757

DASH #	SLIDE RAIL P/N	SLIDE RAIL LENGTH
-7	127545-7	22 IN

UNLESS OTHERWISE SPECIFIED
 DIMENSIONS ARE IN INCHES.
 X.X = ±.050
 X.XX = ±.020
 X.XXX = ±.005
 ANGLES: ±.5°
 INTERPRET TOLERANCING PER ASME Y14.5 - 2009

Sea Tel - Strictly Confidential & Proprietary.
 Do Not Copy, Distribute or Disclose Without Prior
 Written Approval From Sea Tel.
 Copyright © Sea Tel, Inc 2011 - Unpublished Work

DESIGNER/ENGINEER: RANDERSON		DRAWN BY: RANDERSON		 Tel. 925-798-7979 Fax. 925-798-7986	
WEIGHT: 7.7 LBS		DRAWN DATE: 09/15/2011			
MATERIAL:		APPROVED BY:		TITLE: KIT, SLIDE, RACK MOUNT	
FINISH:		APPROVED DATE:		DRAWING NUMBER 135681	
SURFACE ROUGHNESS:		SIZE B	SCALE: 1:2	DRAWING NUMBER 135681	REV A
3rd ANGLE PROJECTION				FIRST USED: 133570	SHEET NUMBER 1 OF 3

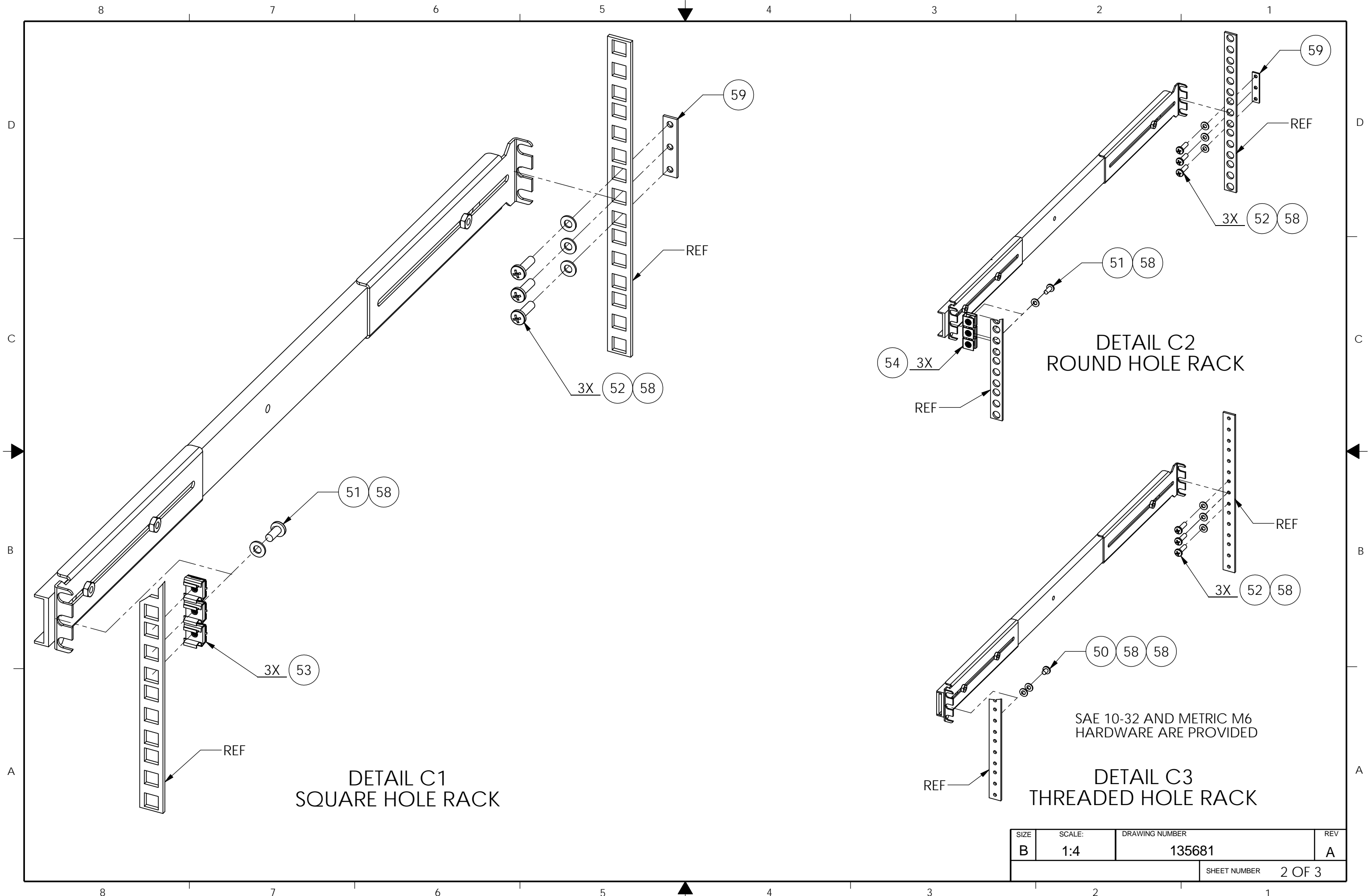

DETAIL C1
SQUARE HOLE RACK

DETAIL C2
ROUND HOLE RACK

DETAIL C3
THREADED HOLE RACK

SAE 10-32 AND METRIC M6
HARDWARE ARE PROVIDED

SIZE	SCALE:	DRAWING NUMBER	REV
B	1:4	135681	A
		SHEET NUMBER	2 OF 3

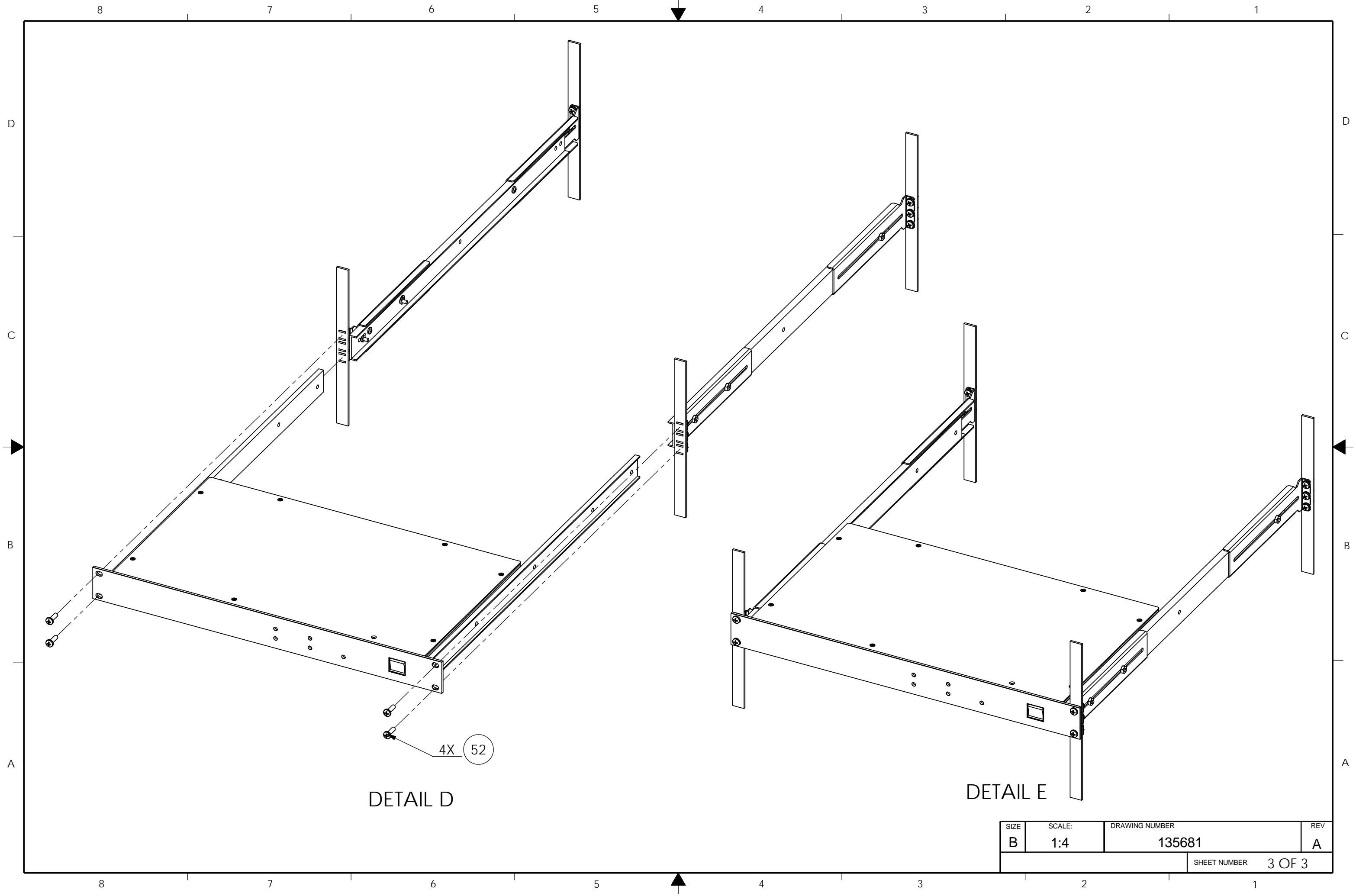

SIZE	SCALE:	DRAWING NUMBER	REV
B	1:4	135681	A
		SHEET NUMBER	3 OF 3